

kettal

2–3

Index

4–5

Designers

6–41

Architecture

8–25 Pavilion H
26–27 Pavilion L
28–35 VDL

38–39 Daybed
40–41 Cottage

42–263

Furniture

44–53 Plumon
54–75 Giro
76–81 Tou
82–87 Altar
88–91 Arc
92–97 Pad
98–106 Il Colonnato
107–111 Ringer
112–128 Molo

129–132 Band
133–139 Vimini
140–149 Cala
150–155 Riva
156–159 Stampa
160–171 Boma
172–179 Roll
180–191 Mesh
192–194 Basket

196–215 Bitta / Grand Bitta /
Bitta Lounge
216–225 Maia
226–236 Park Life
237–251 Landscape
250–257 Net
258–263 Village

264–275

Lighting

266–275 Half Dome
268–275 Bela lamp

270–271 Dots
272–275 Mia

276–291

Shadow

278–281 Paladin
282–285 Meteo S
286–291 Meteo L

292–315

Objects

294–299 Superfan
300–307 Base Kitchen
308–309 Sideboard

310–313 Rugs
314 ZigZag
315 Tutto

316–319

Ecological awareness

322–335

Finishes



Patricia Urquiola



Rodolfo Dordoni



Jasper Morrison



Dion and Richard Neutra



Naoto Fukasawa



Mario Bellini



Nanna & Jørgen Ditzel



Vincent Van Duysen



Konstantin Grcic



Michael Anastassiades



Doshi Levien



Ronan & Erwan Bouroullec



Miguel Milá



Maddalena Casadei & Dunja Weber



Michel Charlot



Emiliana Design Studio

Architecture

Bringing order, form and structure.

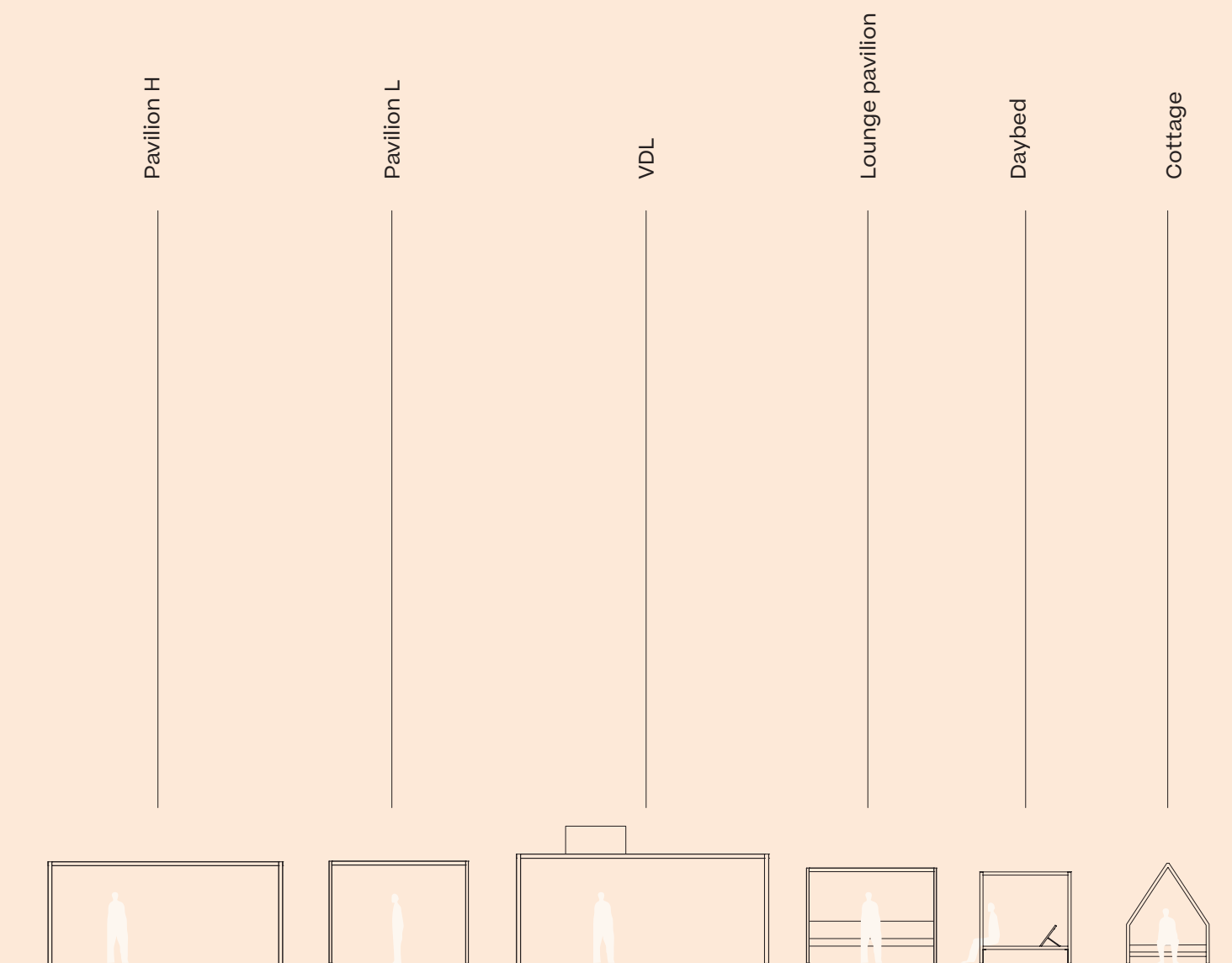

Kettal pavilions seek to bring order, form and structure to outdoor areas. Functionally, they are designed to provide shelter: to shade and cool or protect from the wind and rain.

Pavilion H







Pavilion H





Pavilion H

This new series of pavilions brings the system even closer to architecture, as we have developed more tools for its integration in the architectural environment. The system is now able to adapt more efficiently to different uses and environments: landscapes, architecture, urban environment, maritime, mountain, and so on.

The architecture now has minimal structure, not only for aesthetic reasons, but also to create open spaces that flow freely into each other by means of light, transparency and lightness of structure.

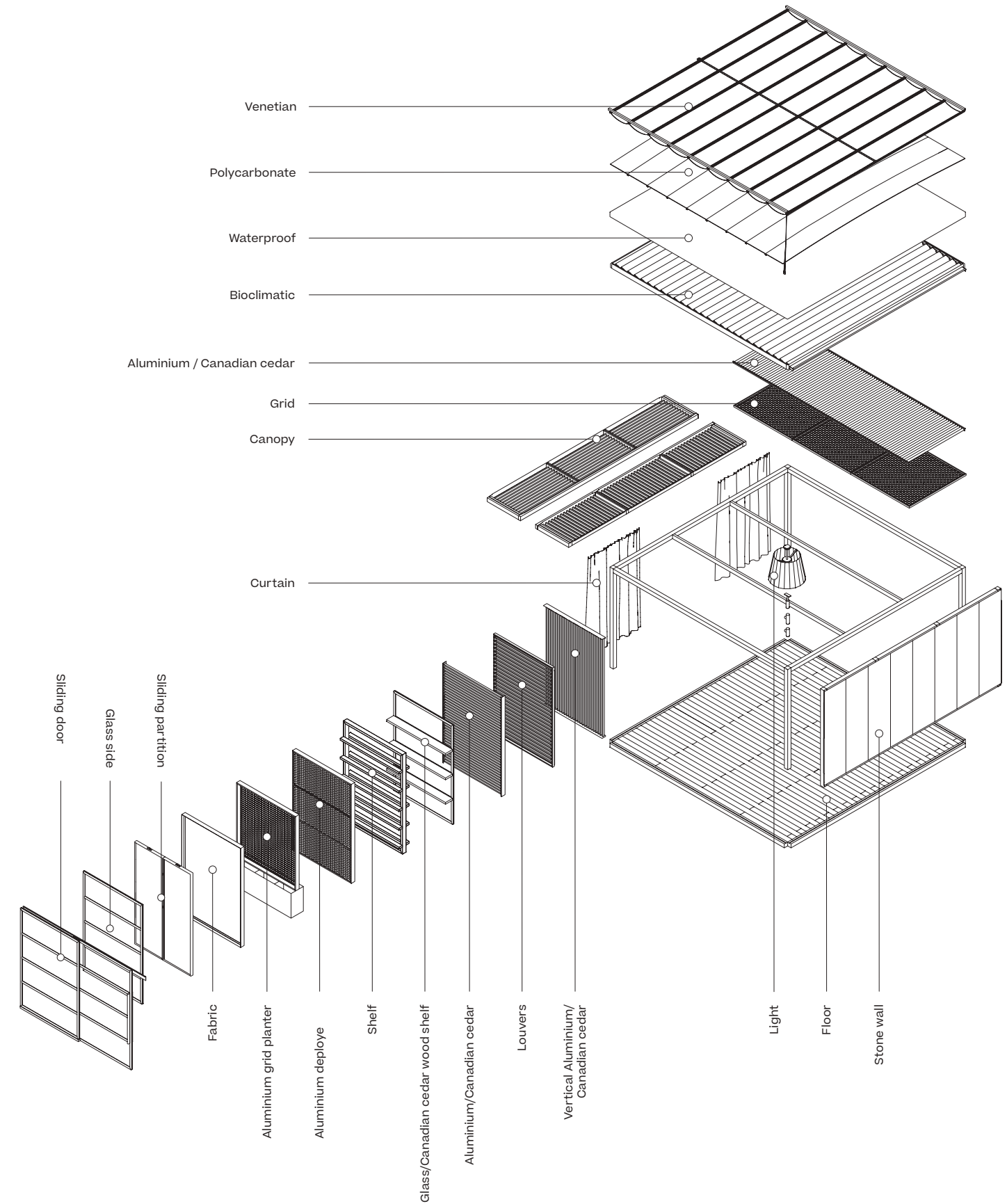
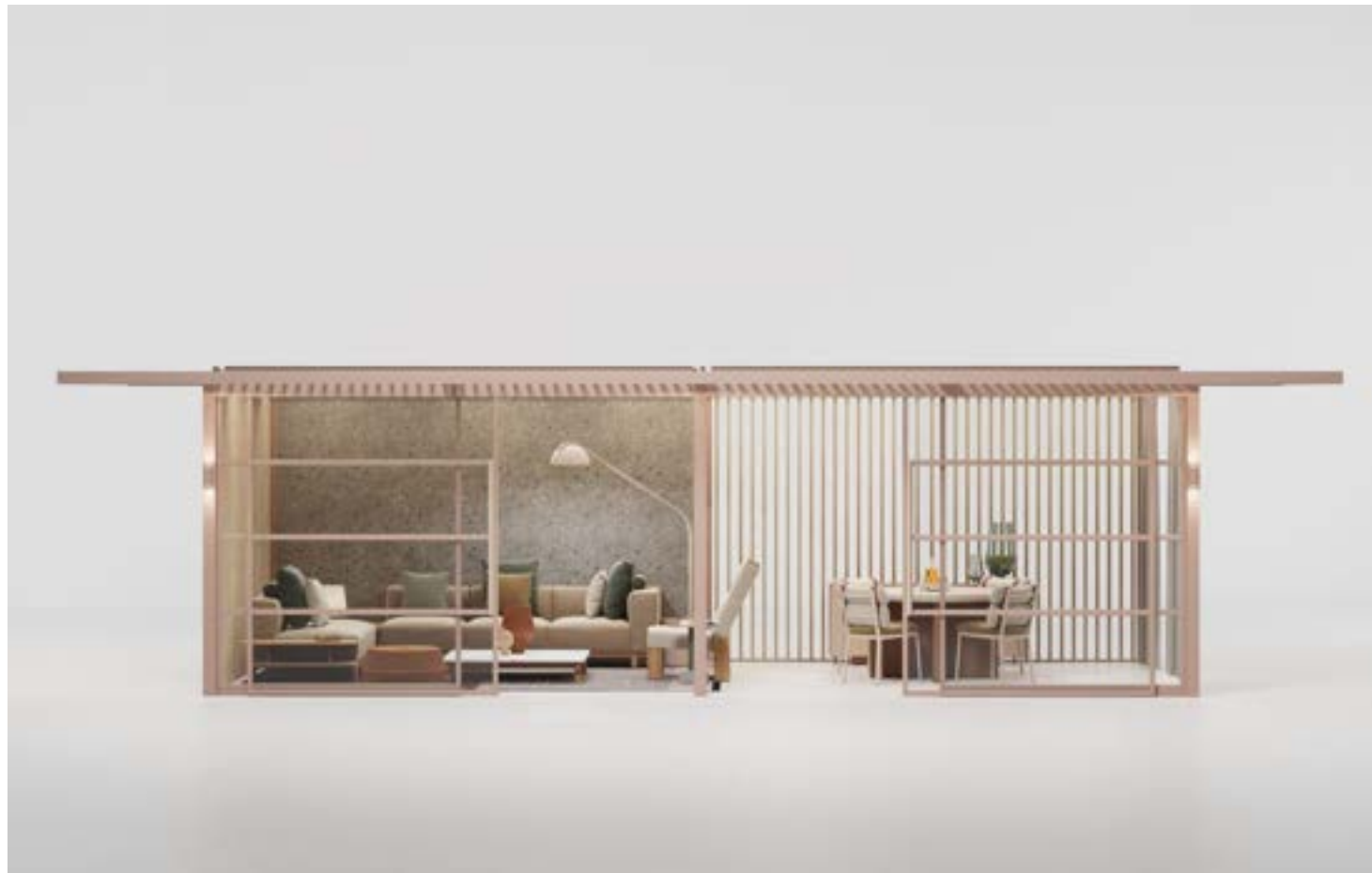

Simple standard sizes cm/inch

4x4 Simple Pavilion

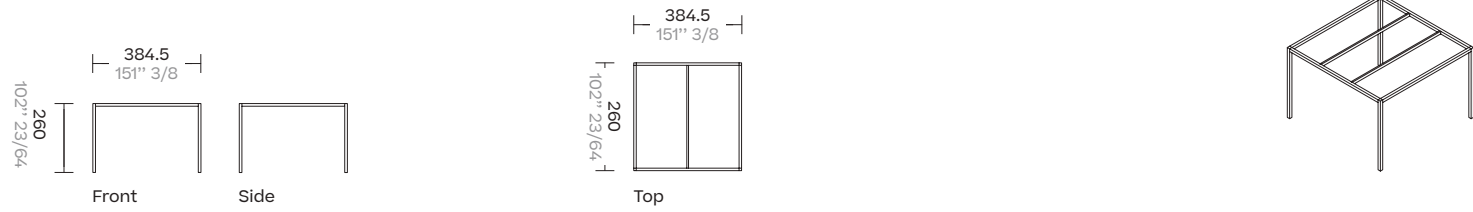

6x4 Simple Pavilion

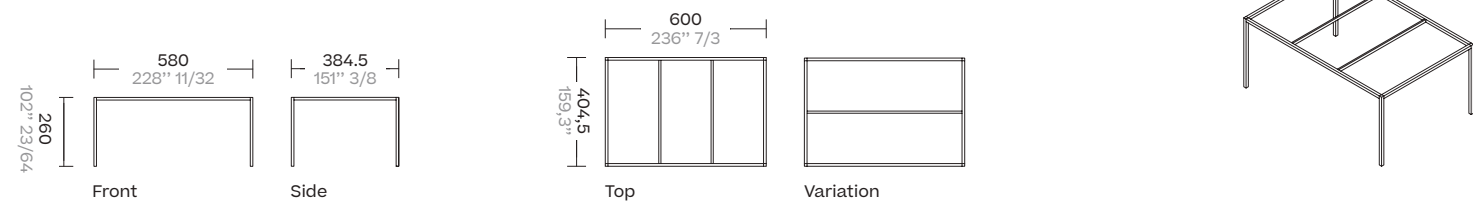

6x6 Simple Pavilion

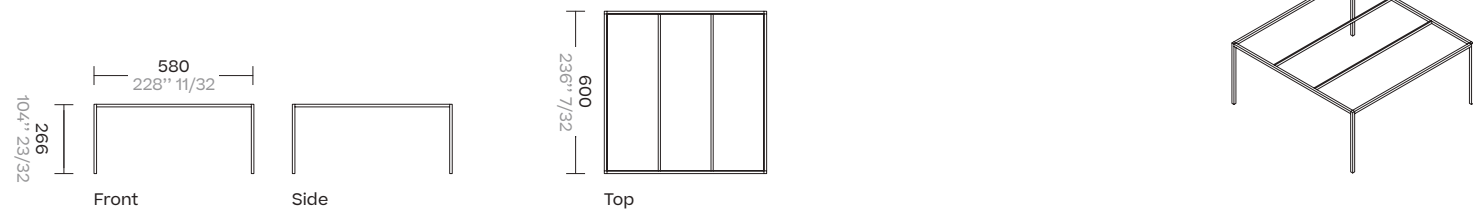

Double standard sizes

8x4 Double Pavilion



8x6 Double Pavilion



12x4 Double Pavilion

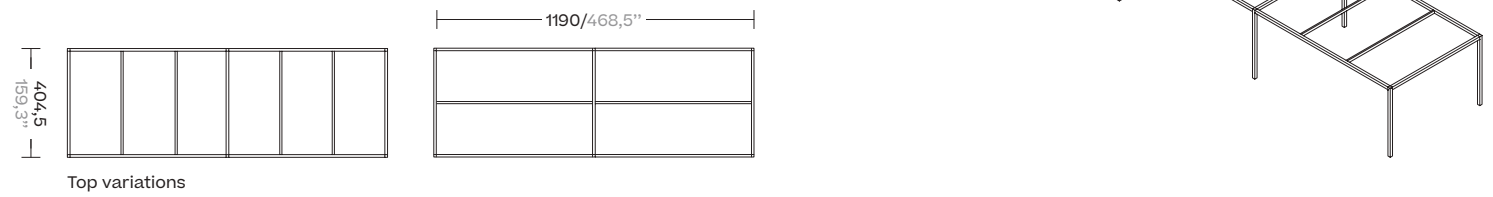

12x6 Double Pavilion

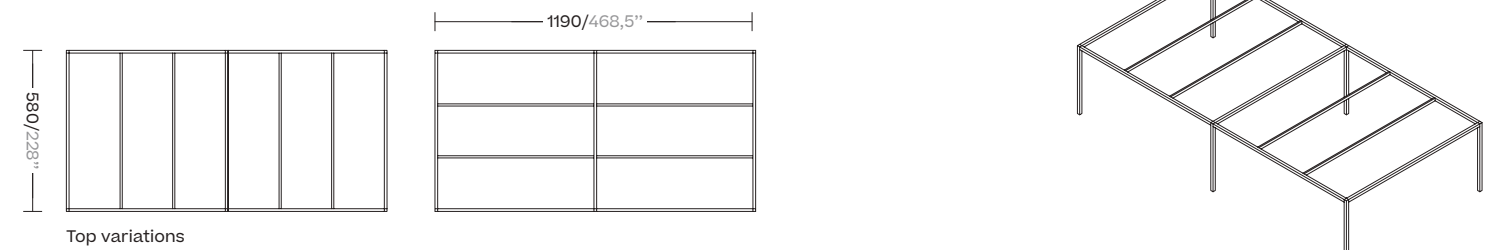

Pavilion H Lighting

Pavilion lighting is an LED lighting system that offers solutions for any type of Kettal pavilion. All luminaires are designed to be used as a point light source or as a continuous line of light providing efficient visual comfort, where quality and aesthetic features are combined. The entire lighting system is integrated into the architecture of the pavilion, in the structure, wall, adjustable louvres and so on, allowing for the installation of all variants of lighting equipment.

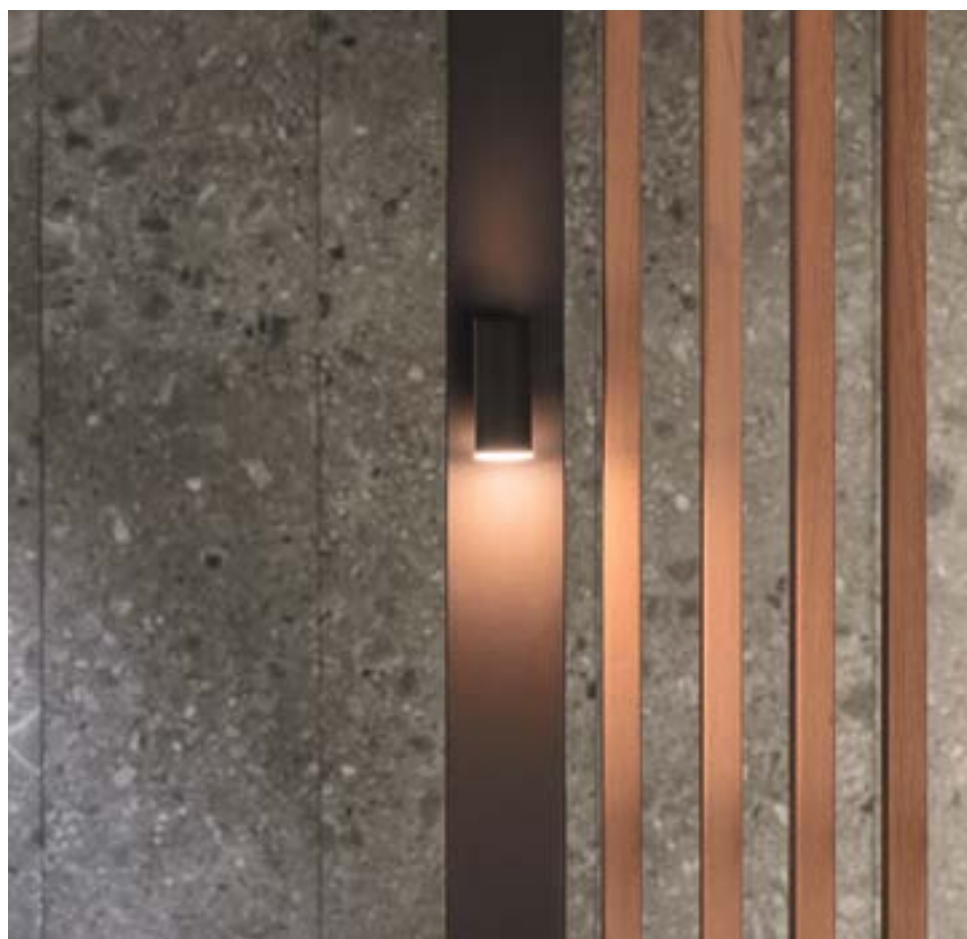

Track system

Integrated

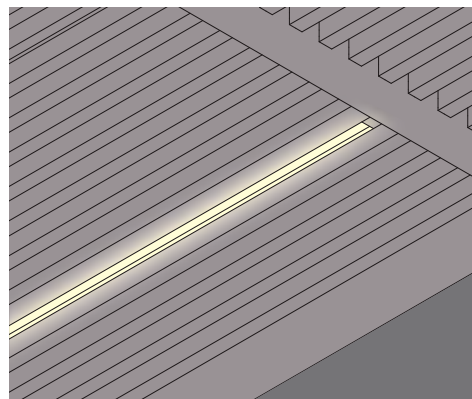

Alumium ceiling integrated LED track

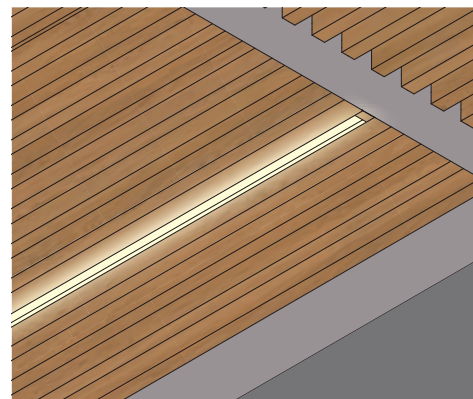

Canadian cedar integrated LED track

Wash light

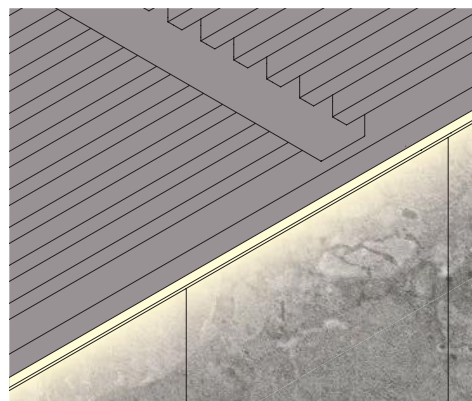

Ceppo Di Gre With Wash Light

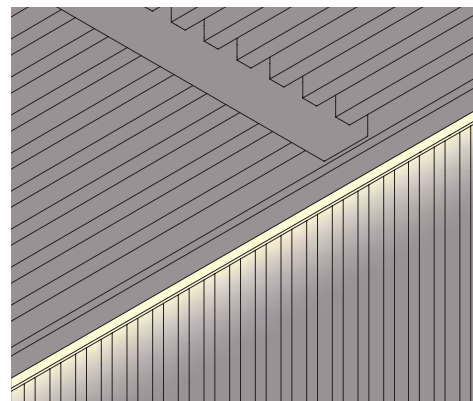

Vertical Aluminium Side With Wash Light

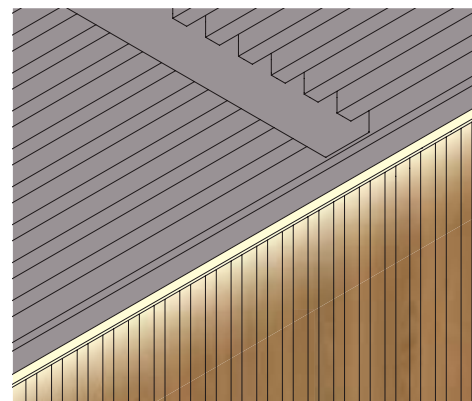

Canadian Cedar Side With Wash Light

Track system

Ceiling

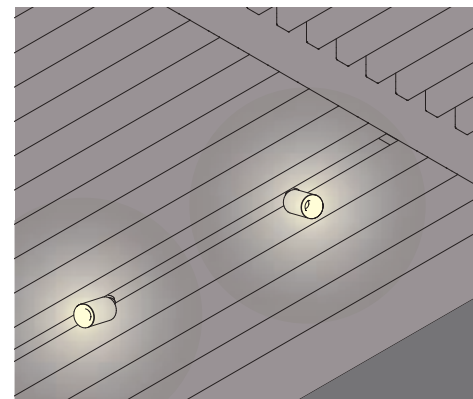

Slats Integrated Dot Light

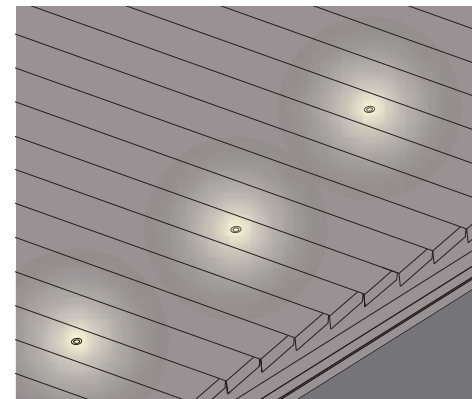

Micro Dots Light

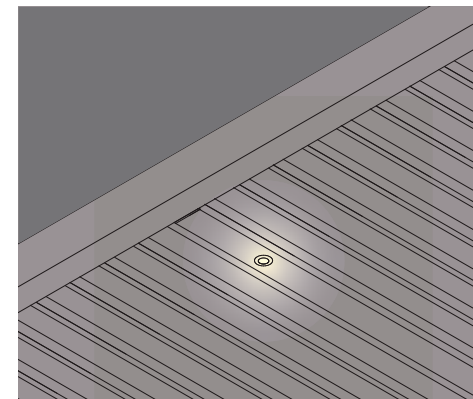

Canopy Micro Dot

Column

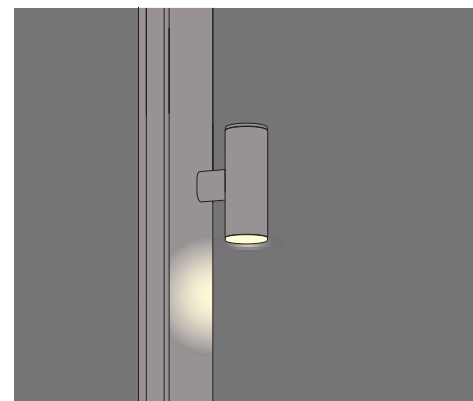

Dots down

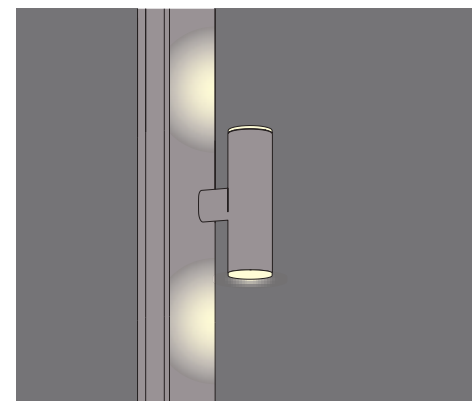

Dots up & down

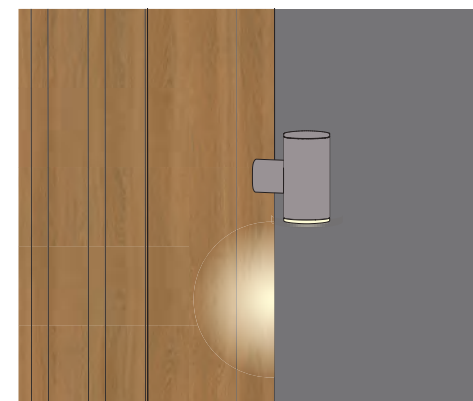

Small Dots down



Dots down



Dots up & down

Pavilion L

The rationalist construction seeks to bring order, form and structure to outdoor areas. Functionally, they are designed to provide shelter: to shade and cool or protect from the elements.

These customisable structures are available in various sizes and configurations, suitable for both indoor or outdoor use.

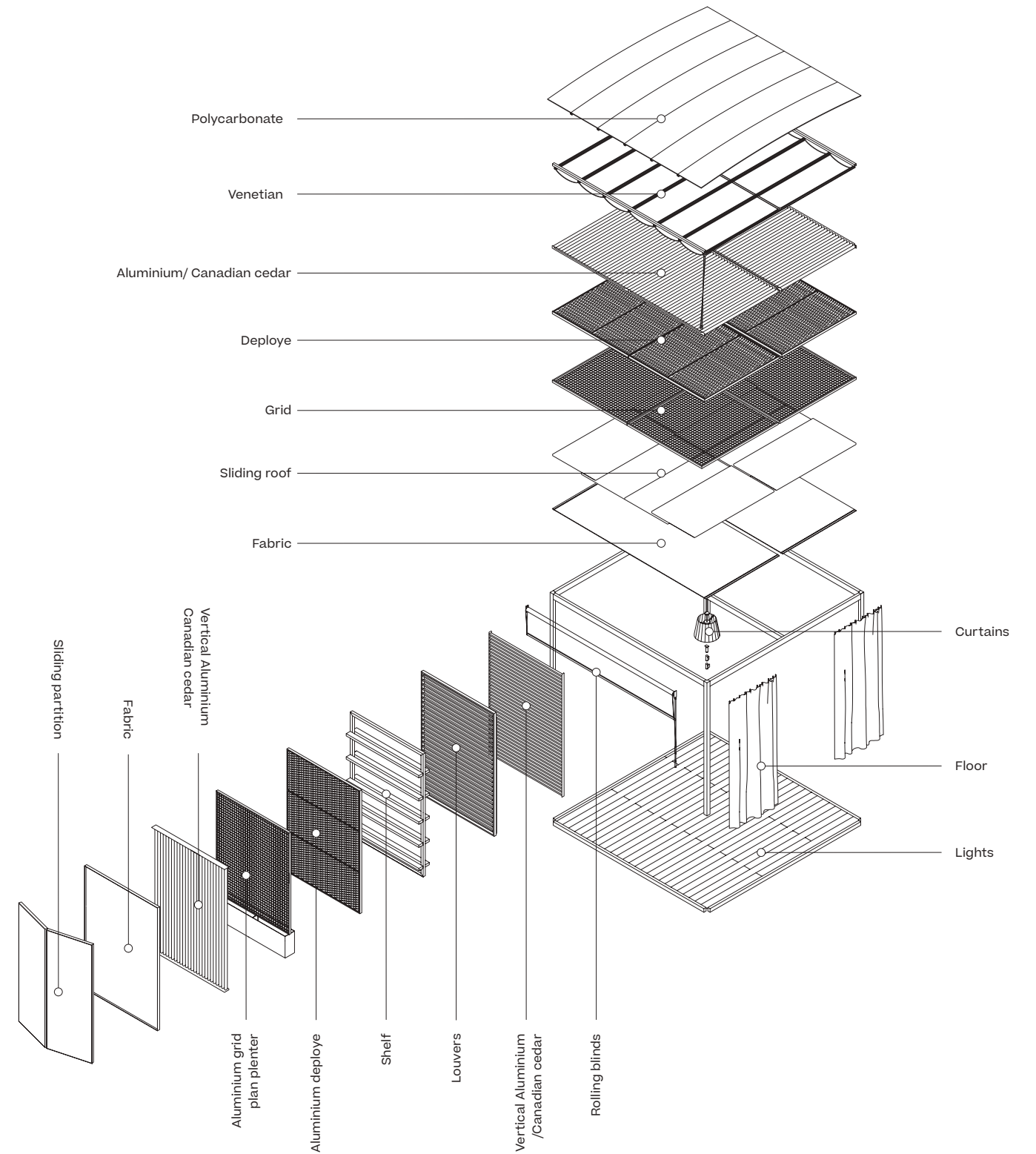

VDL Penthouse, by Richard Neutra





More info





More info



In 1932, Richard Neutra built his house thanks to a donation from the Dutch philanthropist Dr Van Der Leeuw (hence the acronym VDL). This house is a particularly important example of Richard Neutra's work because it encapsulates all the architectural theories that he first posited in his book *Wie Baut Amerika?*, 1927 and later on in his more philosophical reflections *Survival Through Design*, 1953.

Seven years later, when the family had grown, he built an annex in the garden. In 1963, the house was devastated by fire, leaving only the annex standing. At that time, Richard Neutra and his son and colleague Dion Neutra rebuilt the house and added a solarium/atrium on top of the original structure. He incorporated everything he had learned over the years in this reconstruction: modularity, natural climate control, water roofs, interaction with the natural environment, technological advances, etc.

Apart from being his home, the VDL Research House was also his office. In this building, over 30 years, he designed hundreds of international projects. Some of the most representative architects from the Modern American movement also spent time in his practice as apprentices. The house was also a meeting point for the cultural milieu of those times, with visitors such as Julius Shulman, Frank Lloyd Wright, Alvar Aalto, Charles and Ray Eames, Jørn Urtzon and László Moholy-Nagy. In 1990, on the death of Dione Neutra, Richard Neutra's wife and Dion's mother, the house was donated to the California State Polytechnic University, Pomona.



VDL Research House



Daybed



Cottage



Daybed

Daybed uses modern architectural forms that highlight the nature of outdoor environments.

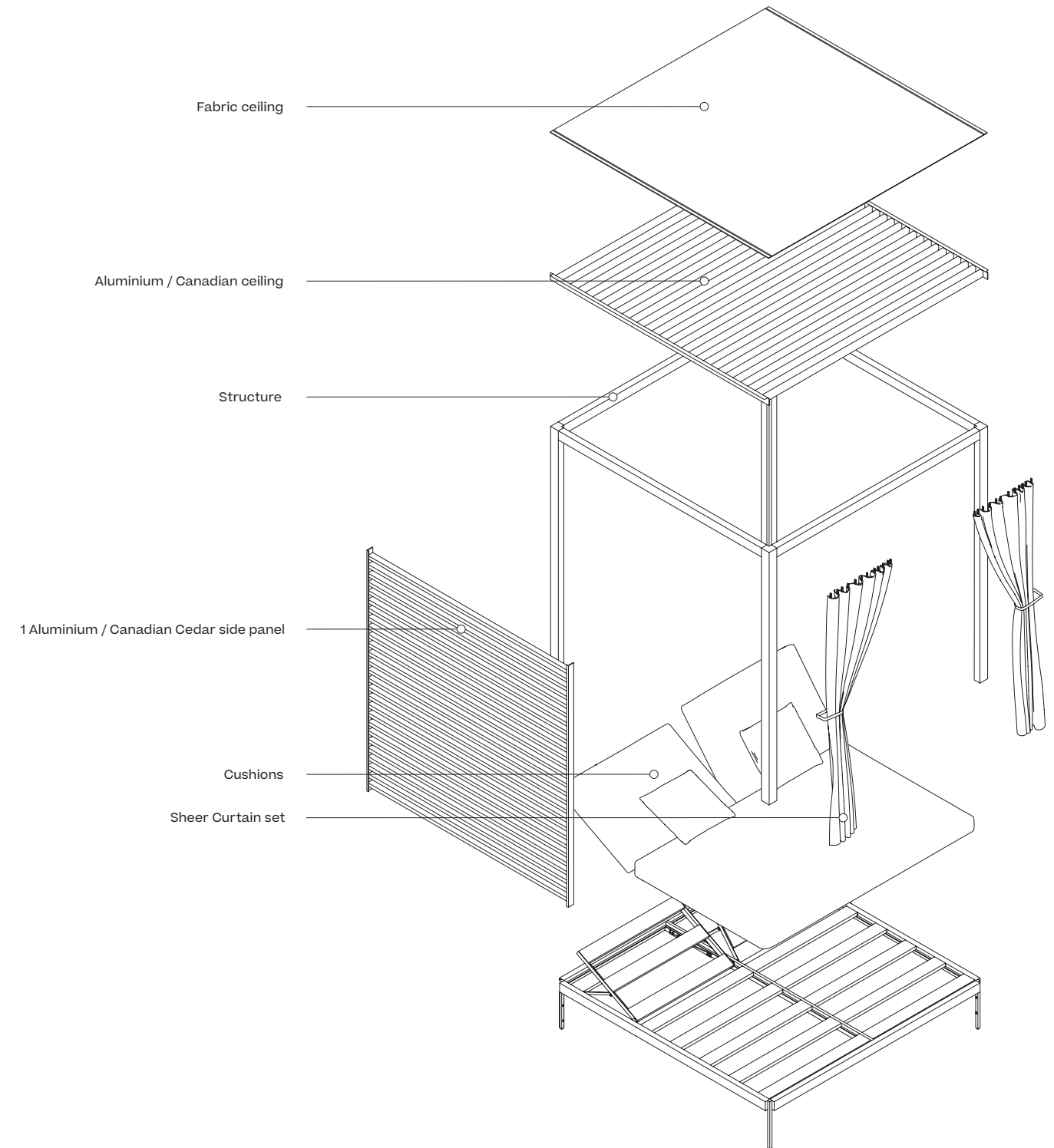
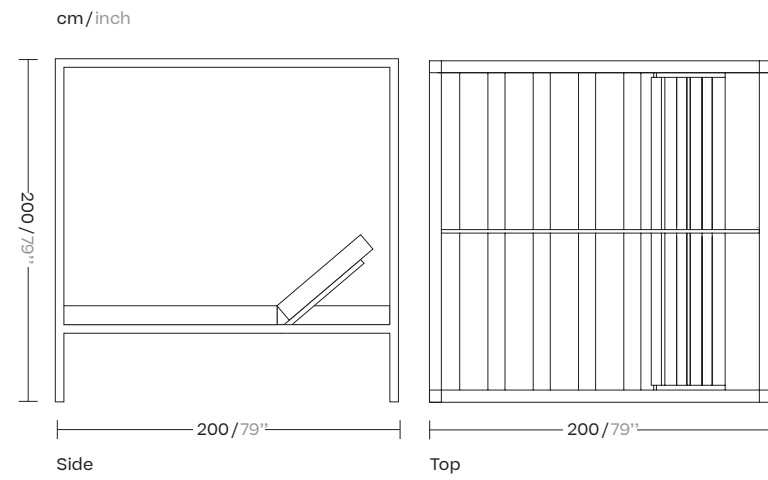

Cottage

Cottage is a charming spot, a place in which to relax in comfort, meditate, rest or simply pass the time in the company of a good book, enjoying the air and the light. It is the definitive refuge in which to enjoy the outdoors.

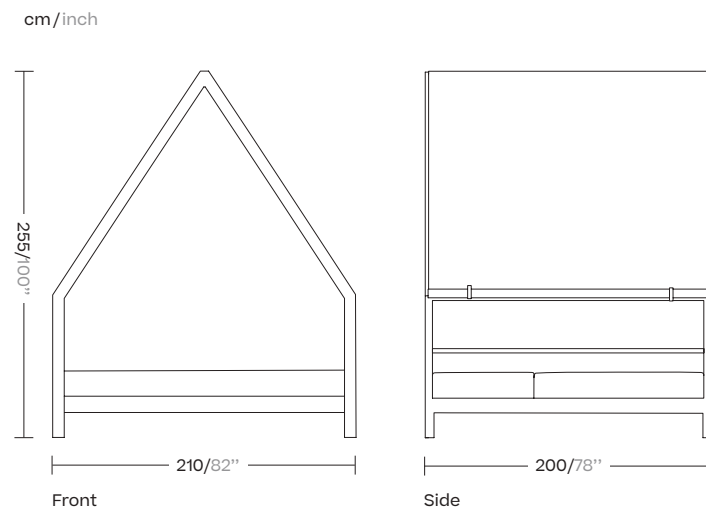

Cottage

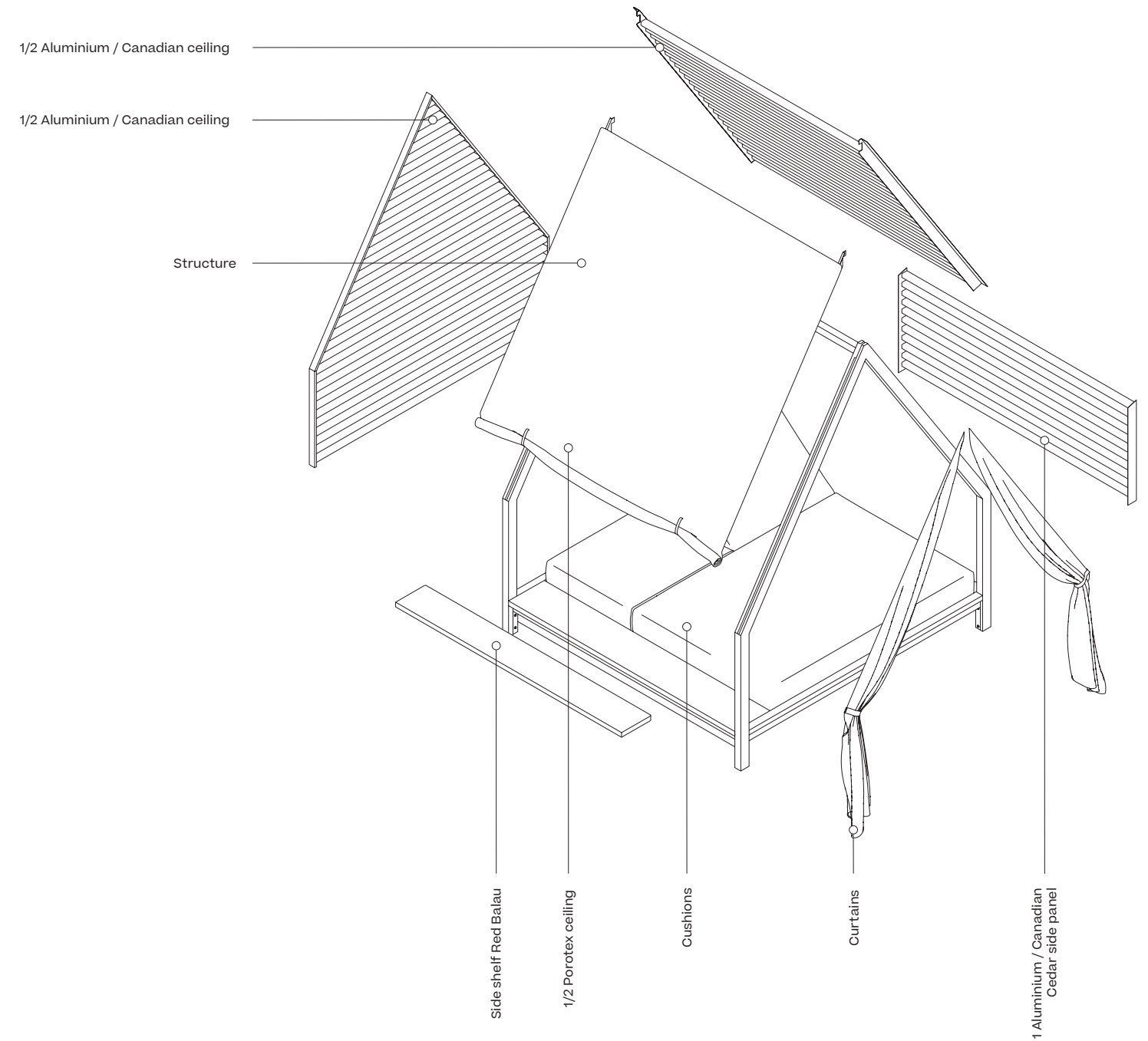

Furniture

Versatile and timeless furniture designed by some of the most important names in the international design scene.

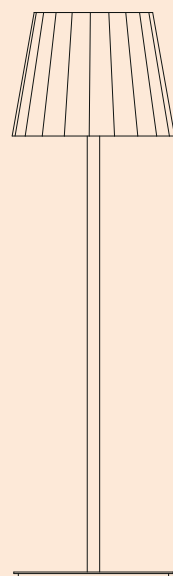
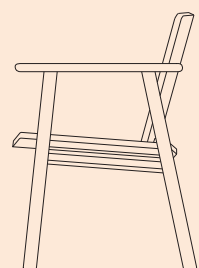
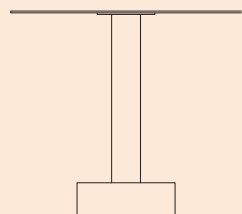
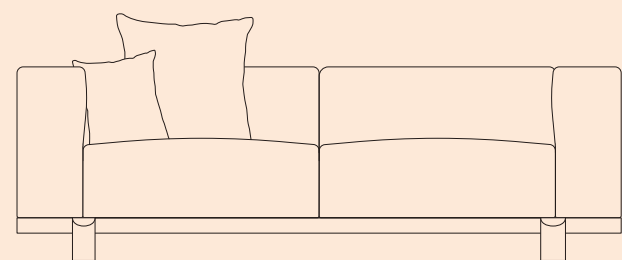

The furniture collection, which is suitable for both indoors and outdoors, is lively and expressive. It features modern classic designs, with an informal and stimulating language, enriched by contemporary colors and materials.



Plumon, by Patricia Urquiola

The new outdoor family designed by Patricia Urquiola for Kettal is based on the concept of clothing, on dressing and undressing furniture. Adopting a tailoring approach, Patricia Urquiola designs the new family with a reference to the characteristic Brazilian spirit, which lives in abundant, roomy, comfortable furnishings, somehow evocative of distant landscapes and cultures. For Plumon, Urquiola designs a light structure, on which a tailored and padded dress is 'moored', wrapped. This

ribbed padding, characterized by stitching, as well as being an aesthetic figure, fulfills the comfort of the product. It is the fit that guides the aesthetics. With a few simple gestures, the dress is placed on the rigid teak structure and embraces it. An extreme ease of use that becomes a real plus for an outdoor collection. A comfort that is also emphasized visually, thanks to the padded dress that generously also embraces the armrests and the outside of the backrest.









Dining Armchair

KS7400600/KS7401900

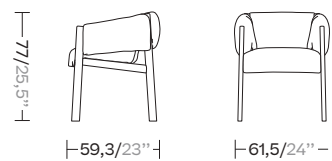

3 Seaters Sofa

KS7400500

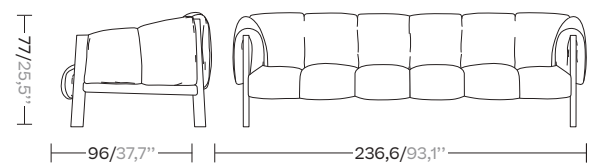

Giro, by Vincent Van Duysen

The core idea and insight behind Giro was a different usage of the rope. It is sewn together in order to create the shape of the product itself. A big source of inspiration was the Orkney Chair. This classic inspired Vincent to draw inspiration from the past with an eye on today and Kettal's technological expertise. Originally based on a natural rope material, it has been reinterpreted through the use of the very sustainable polypropylene material which can face all kinds of weather.





















3 Seaters Sofa

KS7400500 teak
KS7402300 aluminium

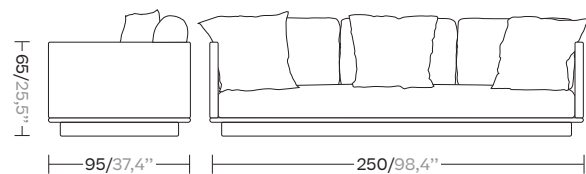

Seater Left or Right Corner module connection

KS7400600/KS7401900 teak
KS7402700/KS7402800 aluminium

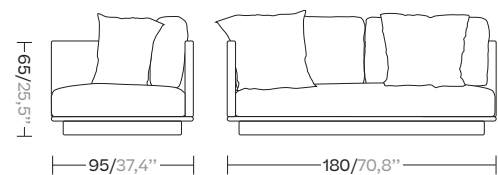

Seater Center Module

KS7400800 teak
KS7402600 aluminium

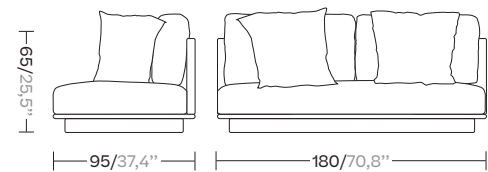

Club Armchair & 1 seater sofa

KS7400300 (club, only teak)
KS7402200 (1 seater sofa, only aluminium)

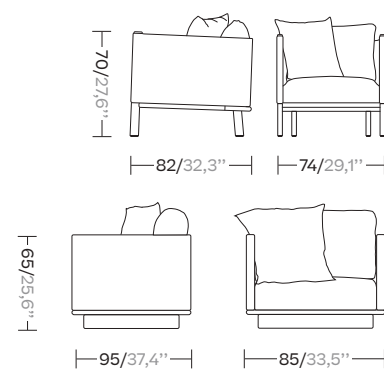

Folding Dining Armchair

KS7400100

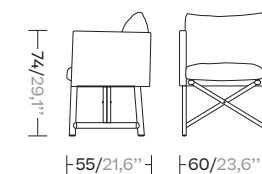

Stackable Dining Armchair

KS7400200

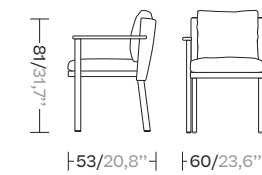



Dining Tables

Ceramic
220x100: KS7401500
290x100: KS7401600

Travertine (under porch)
220x100: KS7403200
290x100: KS7403300

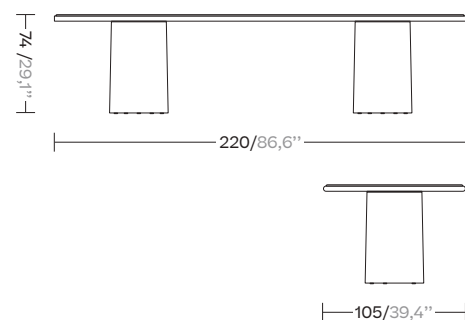

Side Table

Ceramic
KS7401100

Travertine (under porch)
KS7402900

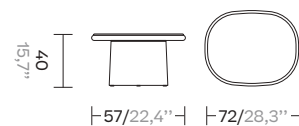

Centre Table ø90

Ceramic
KS7401200

Travertine (under porch)
KS7403000

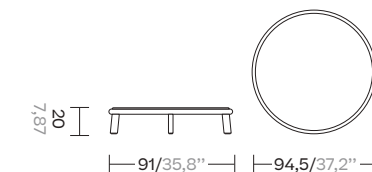

Centre Table ø135

Ceramic
KS7401300

Travertine (under porch)
KS7403100

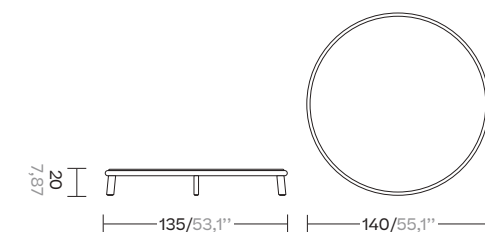

Low Side Table

KS7400900

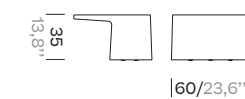

High Side Table

KS7401000

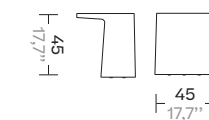

Tou, by Naoto Fukasawa

Tou is our modest tribute to the ancient handicraft of rattan and reed wickerwork, an essential element in the development of both Western and Eastern cultures. Historically, it has been used for all kinds of domestic utensils, furniture and more. The materials are simple and completely natural, but the internal structure of the stem consists of hundreds of cavities, making it both strong and light.

The manufacture combines traditional manual techniques with much more industrial processes. Instead of using the most common form of weaving, we use striped vertical lines, which are lighter and much more expressive than mesh. The outline is smooth and soft, following the natural shapes provided by the material.







Club Armchair

KS6700100 (indoor version)
KS6700200 (outdoor version)

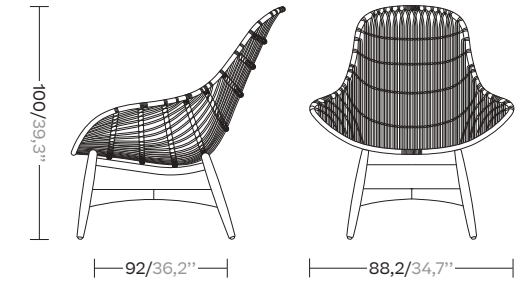

Altar, by Miguel Milá

Miguel Milá designed this table in the mid-sixties as an altar for his wedding. It later became a table for everyday use, but was never produced. As if he were a master craftsman, Miguel Milá designed this piece based on the art of simplicity and efficiency. Its shape hides its complexity, but at the same time

reveals the wood's own character, giving it life and prominence. Its constructive logic makes it strong enough in terms of structure, but formally a beautiful piece. The beauty of logic and common sense understands neither time nor trend.





Dining table

KSA400200

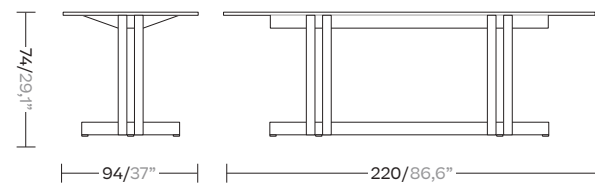

Dining table

KSA400100

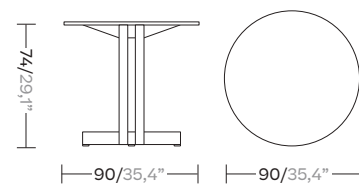



Arc, by Kettal studio

The Arc collection features an enveloping backrest based on fundamental geometry: a constant radius arc. It shows restrained, elegant proportions. The light aluminium frame clearly expresses a desire to maintain armchair tradition. The backrest features simple yet sophisticated braided

strips, while the seat is padded with polyurethane foam covered in matching fabric and the fabric cushion has a removable cover.

The collection is used mostly in hotels, in lobbies and rooms, on cruise ships and also in domestic settings as light furniture in sofa and dining areas.



Dining armchair

KSA500100

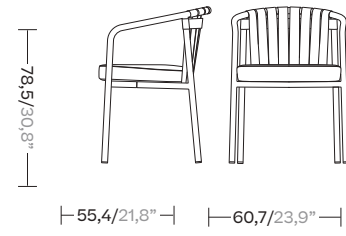

Club armchair

KSA500200

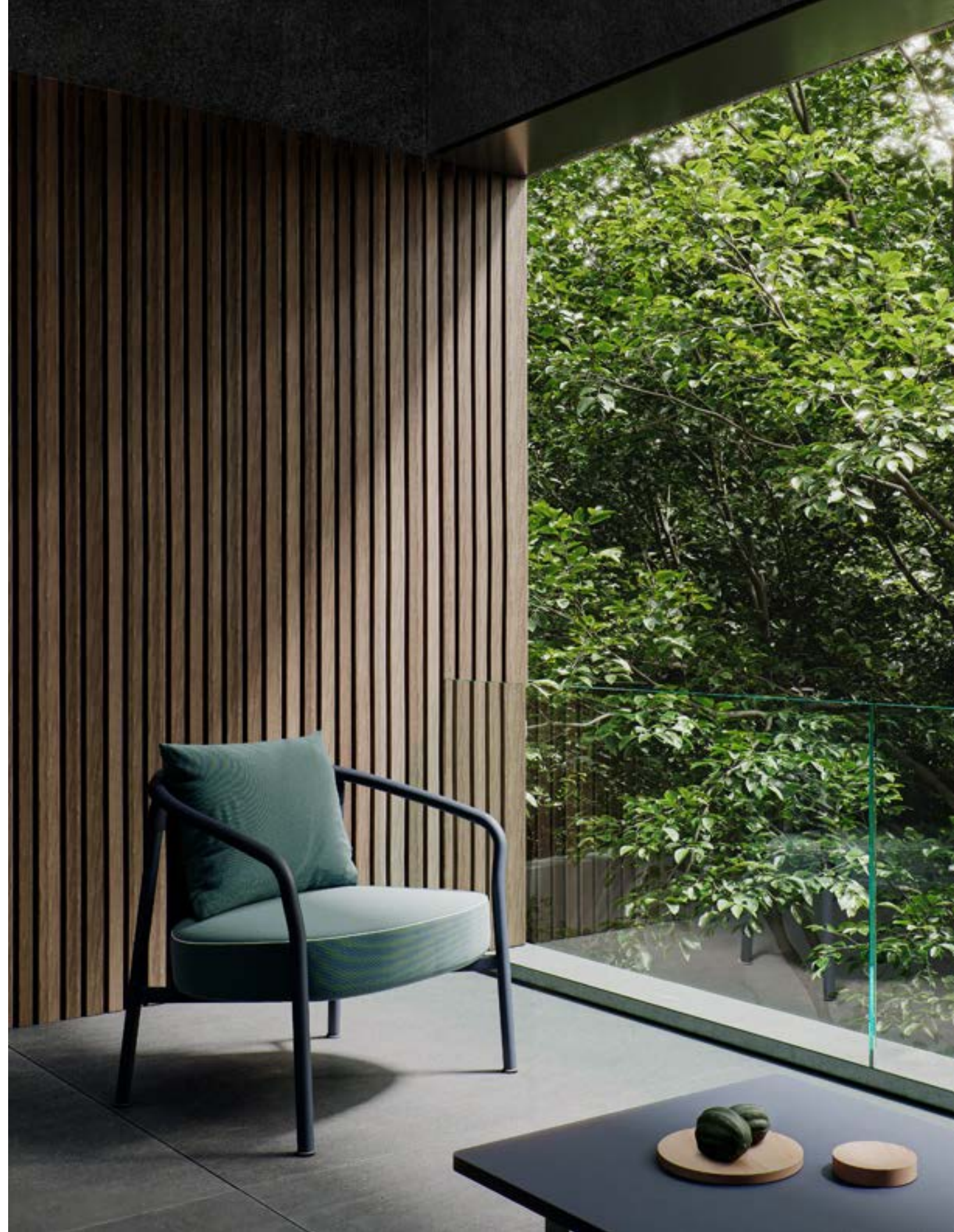
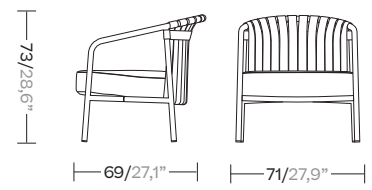



Pad, by Kettal studio

Kettal has made deck chairs for decades, and always of the same excellent quality. This enables us to offer a product that garners all that experience: comfort, durability, stackability and so on. Pad is a sturdy, long-lasting deck chair system designed for relaxing in comfort. It is built to withstand continued

use. The sturdy seat guys and backrest can be easily changed. The ample seat surface and sandwich-style structure make it exceptionally comfortable. With a stretch guy attached to the aluminium frame and optional cushions that add extra comfort.





Deckchair

KSA700100

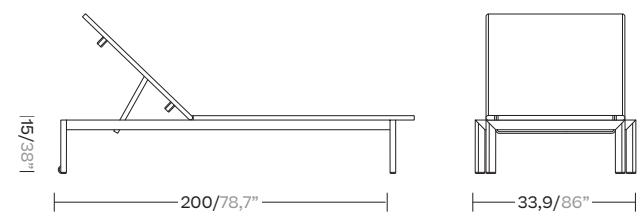

Il Colonnato, by Mario Bellini

In this project, Mario Bellini took his inspiration from a basic elemental structure in architecture. His design emulated the colonnade of classical architecture, in which a sequence of columns supports a portico, in this case a table top. The base is a visually closed volume, despite being materially open. When seen from a different viewpoint, perception changes completely, as the columns no longer overlap and the space appears empty.





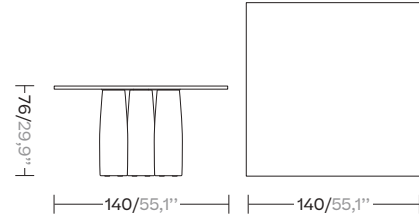





Table Square 140x140

- KSA1-004-00: 4 legs / Teak
- KSA1-001-00: 5 legs / Teak
- KSA1-010-00: 4 legs / Minera Stone
- KSA1-007-00: 5 legs / Minera Stone
- KSA1-016-00: 4 legs / Marble
- KSA1-013-00: 5 legs / Marble



Dining Table ø165

- KSA1-006-00: 4 legs / Teak
- KSA1-003-00: 5 legs / Teak
- KSA1-012-00: 4 legs / Minera Stone
- KSA1-009-00: 5 legs / Minera Stone
- KSA1-018-00: 4 legs / Marble
- KSA1-015-00: 5 legs / Marble

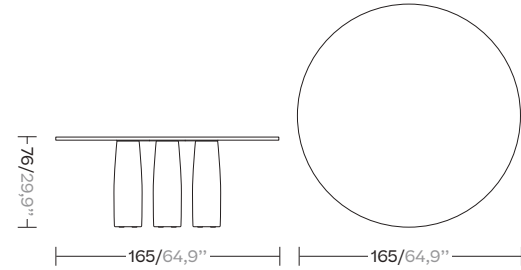

Dining Table 280x140*

*Two parts 140 x 140, union plate included

- KSA1-005-00: 6 legs / Teak
- KSA1-002-00: 8 legs / Teak
- KSA1-011-00: 6 legs / Minera stone
- KSA1-008-00: 8 legs / Minera stone
- KSA1-017-00: 6 legs / Marble
- KSA1-014-00: 8 legs / Marble

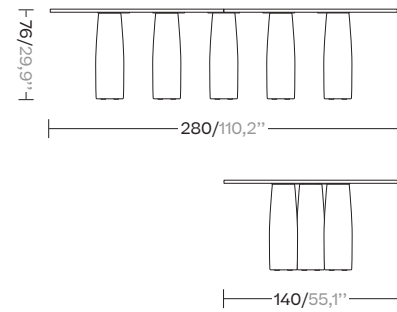

Teak

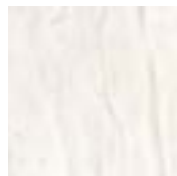

Marble

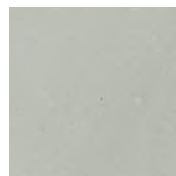

Minera Stone
(2 colours)

Ringer, by Michael Anastassiades

The Ringer Collection is the first collaboration between Kettal and Michael Anastassiades, and it was conceived as a minimalist approach to cafe dining furniture. The title references the traditional Game of Horseshoes, and links to the gesture of the armrest sitting on top of the legs.





Dining Armchair

KS7700100

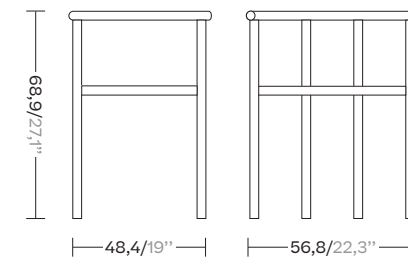

Dining Table Round Base

KS7700200

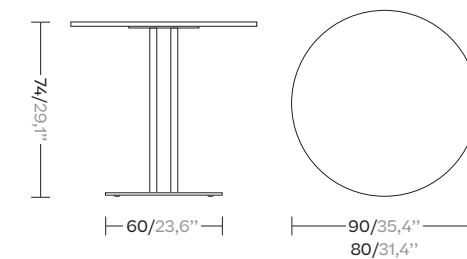

Dining Table Square Base

KS7700300

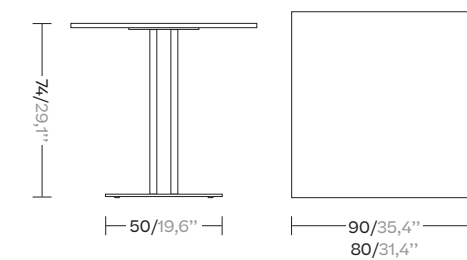

Molo, by Rodolfo Dordoni

This is an example of a modular sofa in its purest form. Its orthogonal geometry is based on a rectangular modularity design, which means it can be easily adapted to suit any situation and optimize the space in which it sits. Each module can be taken apart and re-organized, creating new uses and configurations.

The design is aesthetically minimalistic with intentionally oversized pieces. On the other hand, the decorative elements have been consciously de-emphasized in order to give centre stage to the various combinations of fabric, colours and carefully selected details.













2 Seater Sofa

KS42XX...
KS421XX...

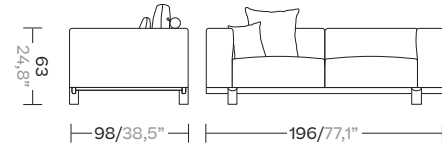

Bench 2 Seater

KS420XX...
KS422XX...

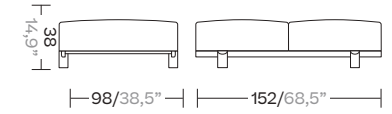

2 Seater Left Corner & Right Corner

Right
KS420XX...
KS421XX...

Left
KS420XX...
KS421XX...

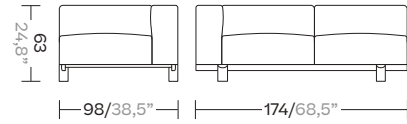

3 Seater Sofa

KS420XX...
KS421XX...
KS422XX...

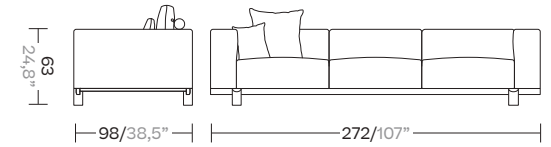

2 Seater Left Corner Open & Right Corner Open

Right
KS420XX...
KS421XX...

Left
KS420XX...
KS421XX...

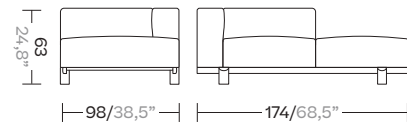

3-Seater Right Corner & Left Corner

Right
KS420XX...
KS421XX...
KS422XX...

Left
KS420XX...
KS421XX...

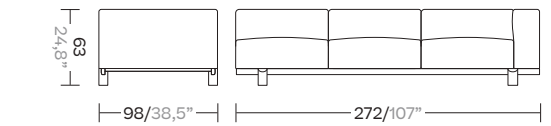

2 Seater Center Corner

KS420XX...
KS421XX...

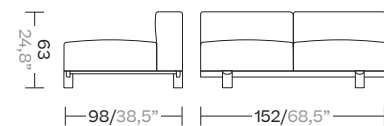

3 Seater Left Corner Open & Right Corner

Right
KS420XX...
KS421XX...

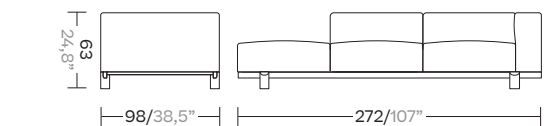



3 Seater Bench

KS420XX...
KS422XX...

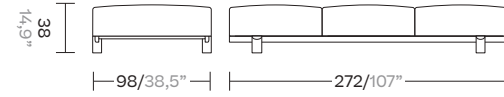

Molo Cushion

KS4211000

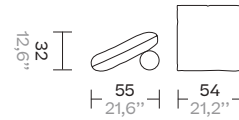

4 Seater Sofa

KS420XX...
KS421XX...

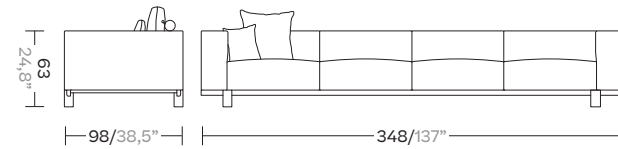

4-seater Right corner & Left Corner

Right
KS420XX...
KS421XX...

Left
KS420XX...
KS422XX...

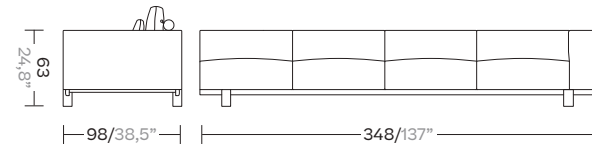

4 Seater Left Corner Open & Right Corner Open

Right
KS420XX...
KS421XX...

Left
KS420XX...
KS422XX...

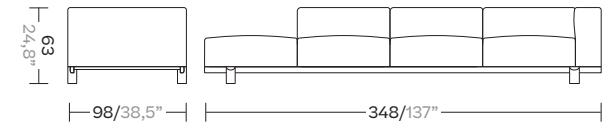

Bench 4 Seater

KS421XX...
KS422XX...

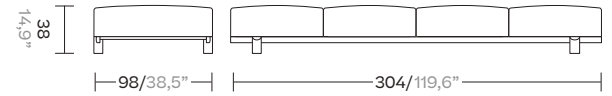

Corner

42540000TB
425400R0TB
4254087GTB
4254089GTB

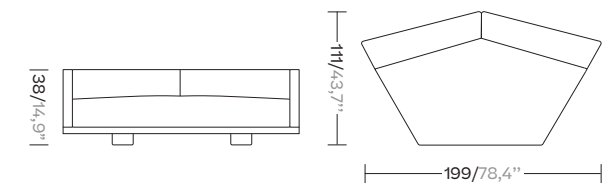

2 Seater Sofa XL

KS4201900
KS4202100
KS4223000
KS4223100

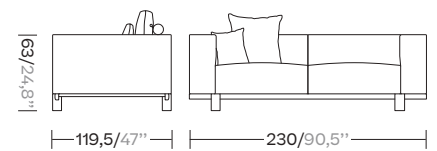



3 Seater Sofa XL

KS4202000
KS4202200
KS4223200
KS4223300

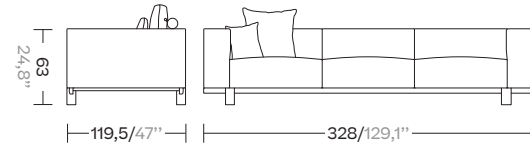

Chaise Lounge

KS4211100

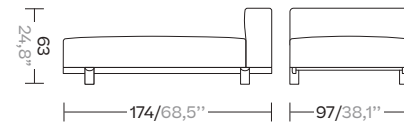

Double Chaise Lounge

KS4211200

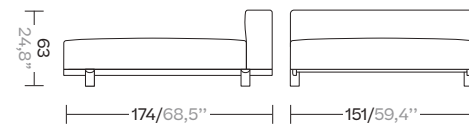

Light cushion

KS5706300

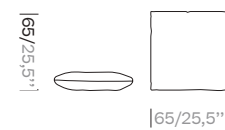

Side table

97x35x20
38,2"x13,8"x7,9"



Back table

75x35x20
29,5"x13,8"x7,9"



Corner table

97x97x20
38,1"x38,1"x7,8"



Teak Legs (L/XL Version)



Concrete Legs (L Version)



Low Legs (Only XL & Daybeds)



No-piping



Piping



Centre Table 160x94 and 120x120

Centre table 160x94
KS4210600

Centre table 120x120
KS4210700

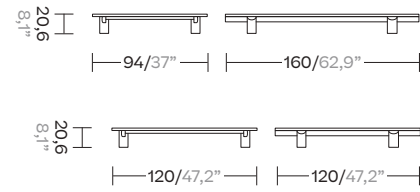

Deckchair with Small Wheels & with Wheels

With small wheels
KS4210800

With wheels
KS4210900

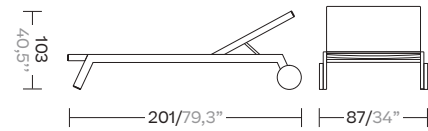

Band, by Patricia Urquiola

The idea behind the Band collection is the breakdown of structure. It is an object designed using an ensemble of pieces. The chair's design intentionally challenges the classic sophisticated lines of furniture design and becomes something schematic — a conceptual program. It is a structure made up of repetitive angular shapes that give centre stage to its raw materials and it can be formed entirely of aluminum or teak wood, as well as Terrain Fabrics.





Dining Chair

Aluminium
KS2800100

Teak
KS2800200

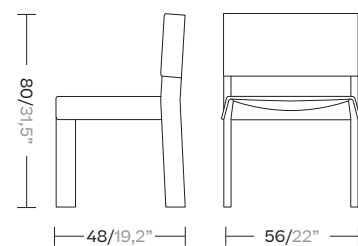

Dining armchairs

Aluminium
KS2800300

Teak
KS2800400

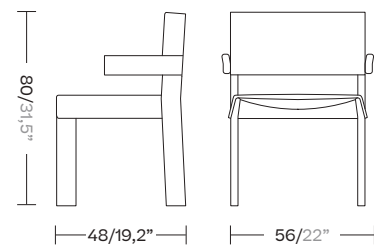

Club armchair

Aluminium
KS2800500

Teak
KS2800600

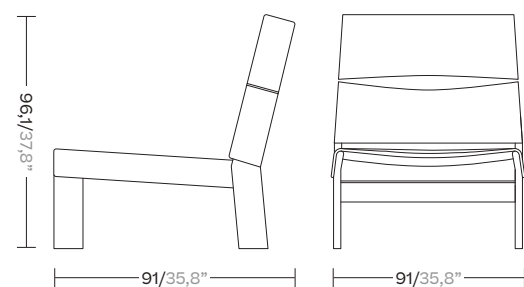

Vimini

Vimini, by Patricia Urquiola

Vimini means wicker in Italian and it also sounds like Bimini, the name of an island the designer likes. It uses just the right amount of outdoor wicker with a rougher wooden frame. It does not have the same modernist spirit as the Basket (which the original inspiration came from) but it is familiar enough that, when you get close, it stirs a memory and makes one feel at home. That is what it is, more or less – an object of memory.







Dining Armchair

KS1500100

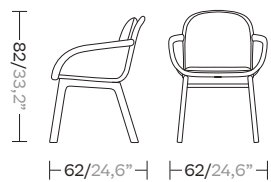

Side Table ø39

KS1500600

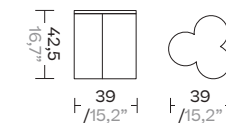

2 Seater Sofa

KS1500200

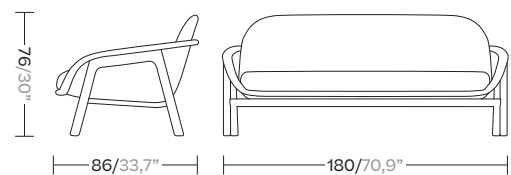

3 Seater Sofa

KS1500300

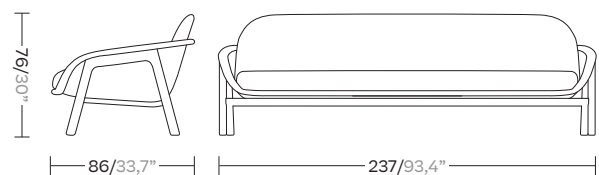

Centre Table

KS1500400

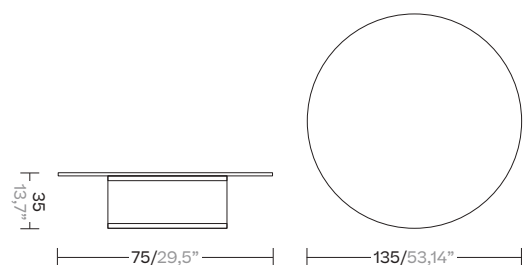

Cala, by Doshi Levien

Cala is a high-backed armchair inspired by the iconic Emanuelle. The chair has a majestic spatial presence with transparent and light surfaces. The open weave of the rope provides a latticed window for visual privacy while maintaining a connection to the natural elements.

Cala may be used for outdoor dining as well as a chair to lounge in. The wide selection of metal coatings, rope colours and cushion fabrics offer many possibilities to tailor the identity of the chair to suit different projects.









Dining Armchair

Wood legs
KS2700200

Aluminum legs
KS2700100

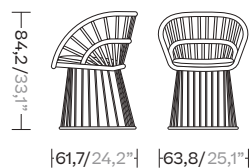

Stackable Dining Armchair

KS2700400

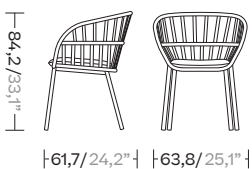

Club Armchair

Wood legs
KS2700600

Aluminum legs
KS2700500

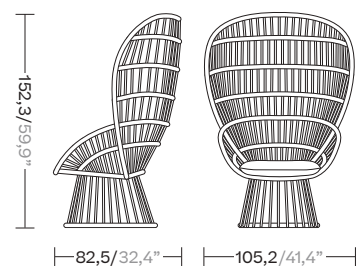

2 Seater Sofa

KS2700700

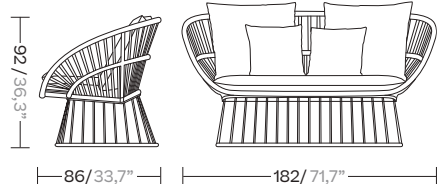

3 Seater Sofa

KS2700800

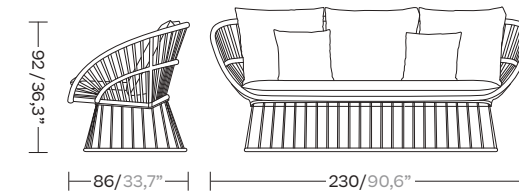

Pouf ø135

KS2700900

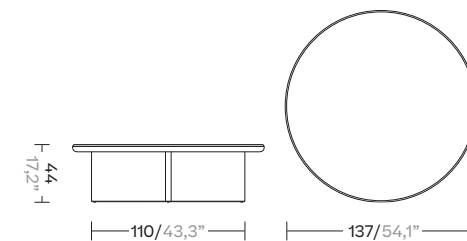

Pouf ø180

KS2701000

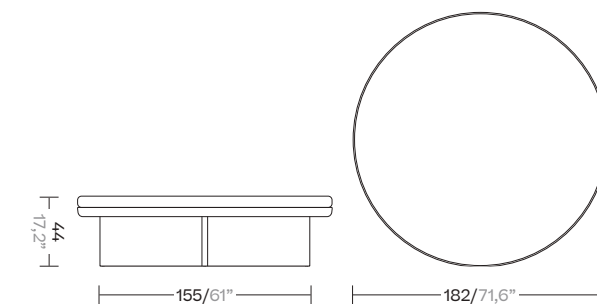

Side Table ø48

KS2701100

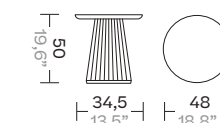

Centre Table ø135 and ø80

ø135
KS2701200

ø180
KS2701300

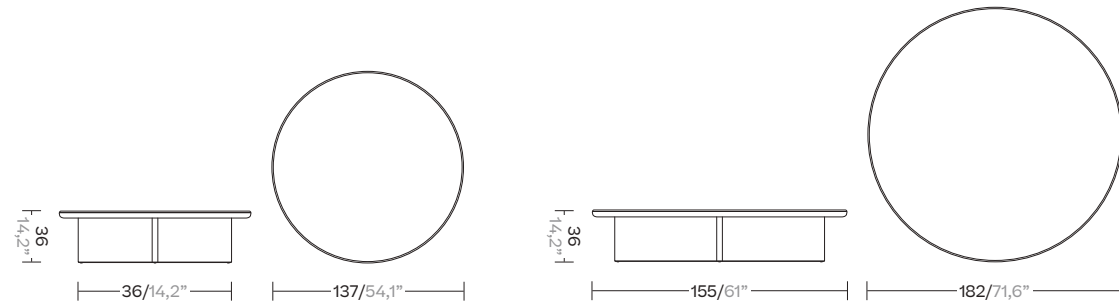

Dining Table ø135 and ø180

ø135
KS2701400

ø180
KS2701500

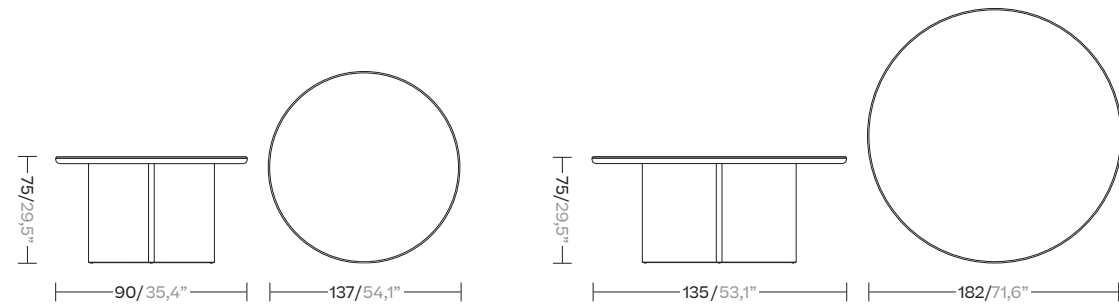

Oval dining table 280x110

KS2701600*

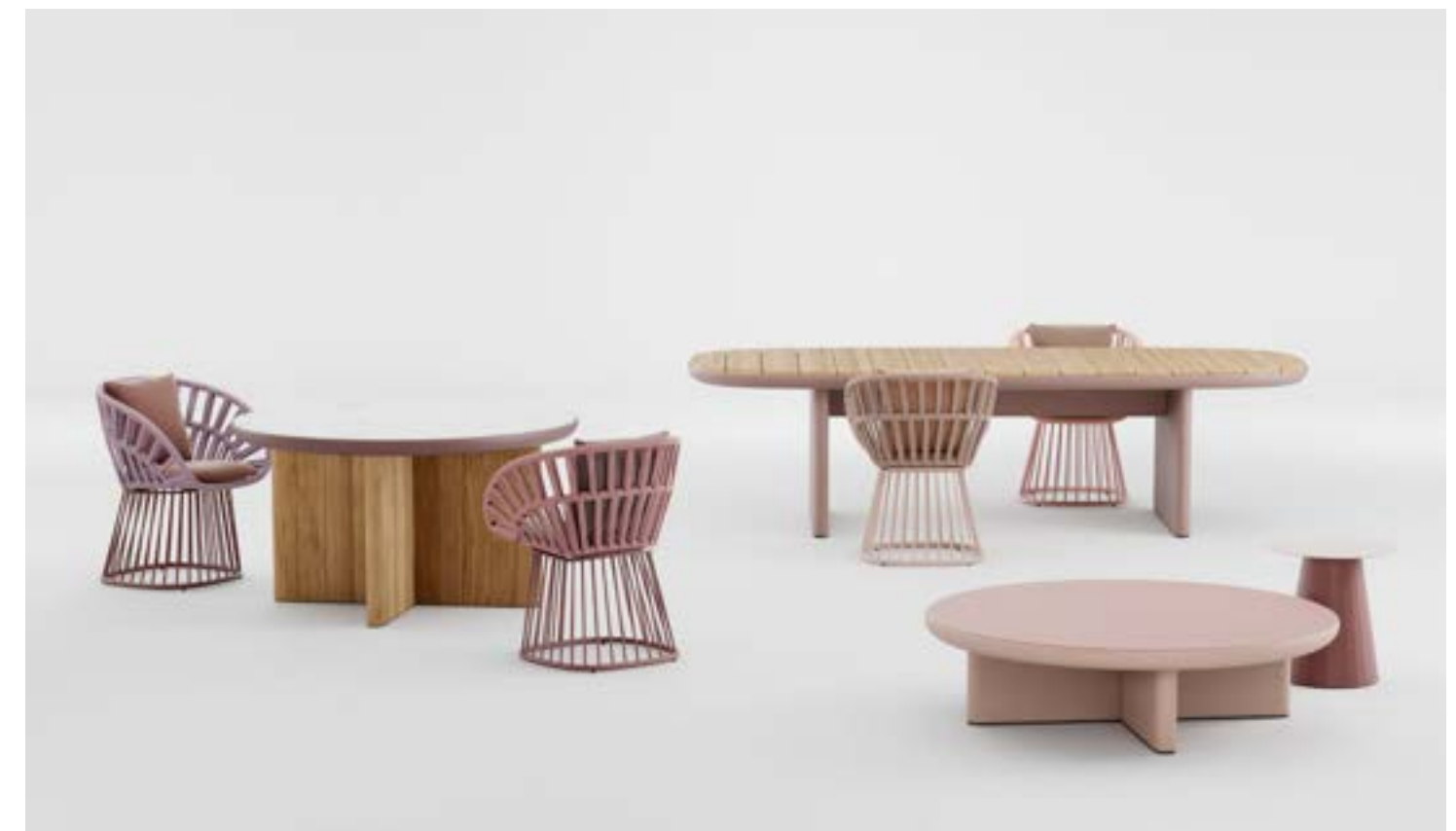
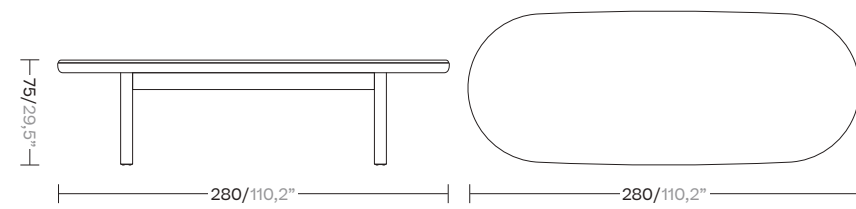

Riva, by Jasper Morisson

The Riva collection of outdoor furniture is above all about achieving a certain atmosphere for the better enjoyment of outdoor space. The plank construction of seat and back follows a long and varied tradition of outdoor chairs made in similar ways, and which, in this case, actually provides a high level of comfort and good looks too.







3-seater Sofa

KS2600700

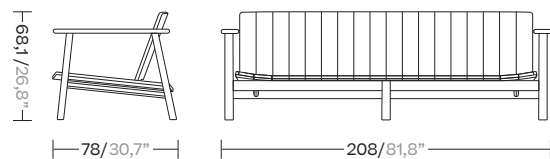

2-seater Sofa

KS2600600

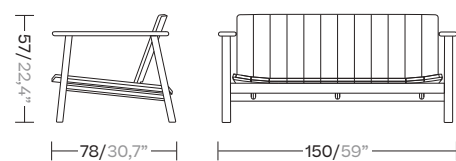

1-seater Sofa

KS2600500

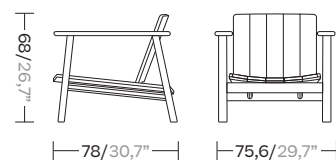

Low club armchair

KS2600300

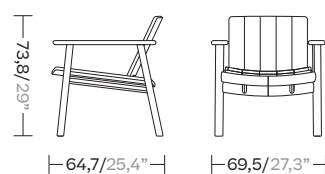

Dining Armchair

KS2600100

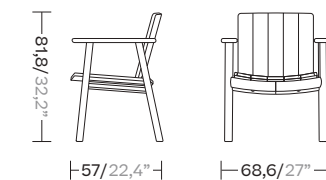

Dining Table 220x94

KS2600200

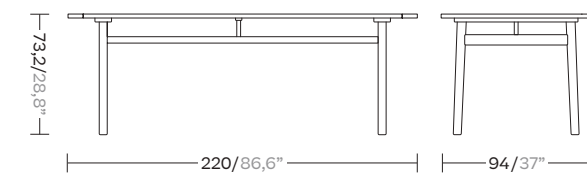

Centre Table 150x80

KS2600800

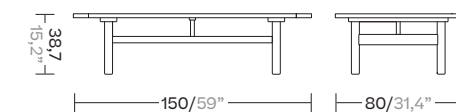

Side Table

KS2600900

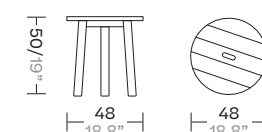

Stampa, by Ronan & Erwan Bouroullec

Stampa is an aluminum chair inhabited by carefully organized holes, made through the technique of punching metal sheets. This pattern, resembling textile sensations, offer a robust yet delicate design that can assume the passage of time.





Dining Armchair

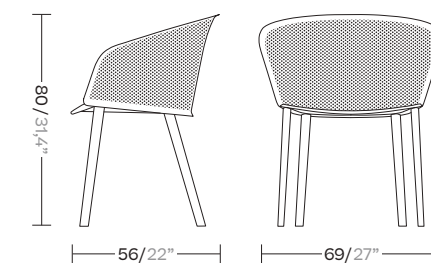

KS2200100



Cushion

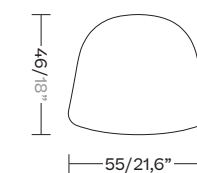

22105-...

Boma, by Rodolfo Dordoni

The Boma collection was born from the need for high performance in outdoor environments, without sacrificing on the increasing demand for comfort.

The structure is organized around a frame entirely made of aluminum, which is capable of hiding in the essentiality of its lines both the quality of the materials used and the possibility of easy articulation in different compositions.











Club Armchair

KS2500100

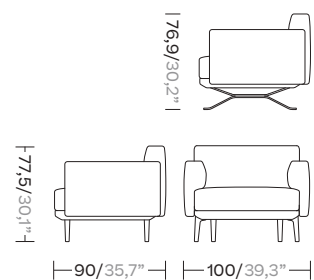

Right & Left Daybed

Right
KS2500500
Left
KS2500600

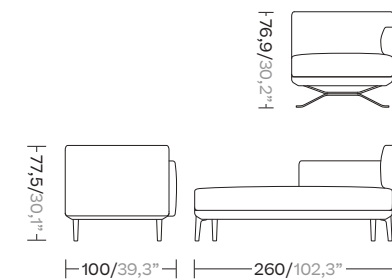

2-Seater Sofa

KS2500200

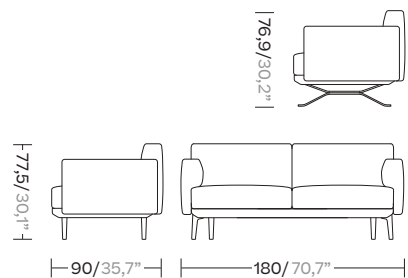

Bench

1-Seater
KS2500800
2-Seater
KS2500900
3-Seater
KS2501000

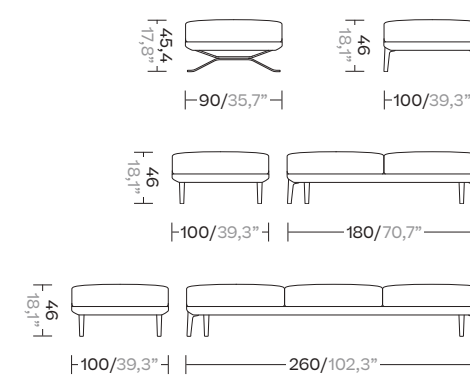

3-Seater Sofa

KS2500300

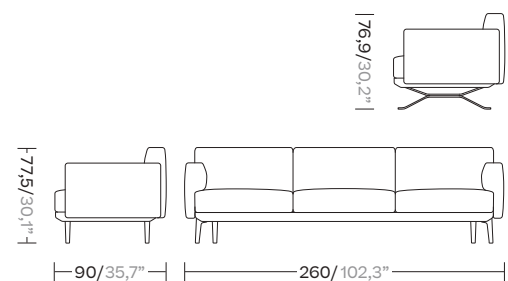

2 Seater Right & Left Corner Connection

Right corner
KS2501200
Left corner
KS2501500

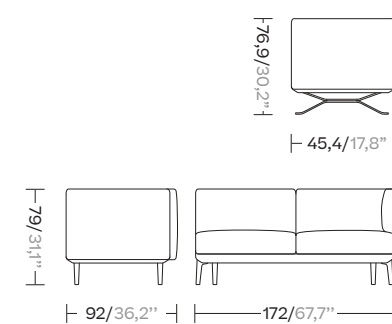

4-Seater Sofa

KS2500400

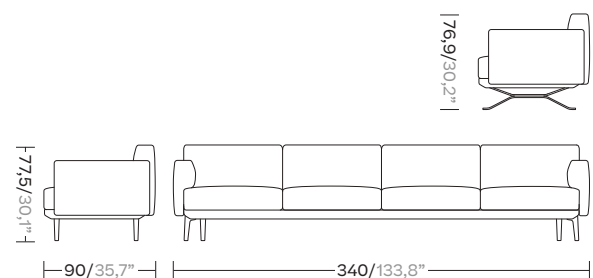

2 Seater Right & Left Corner Connection-Open

Right
KS2501300
Left
KS2501600

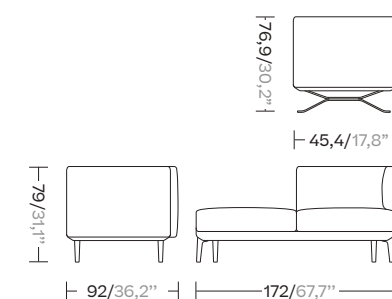



2 Seater Right & Left Corner End

Right
KS2501400

Left
KS2501400

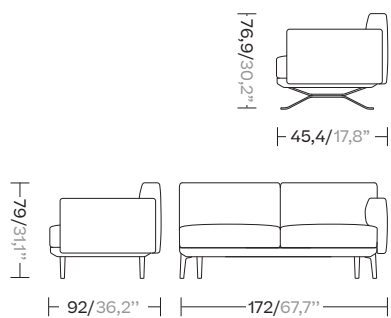

Pillow

KS5703500

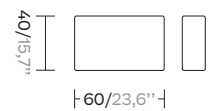

See the Boma concept
scanning this QR code



Roll, by Patricia Urquiola

This ironical intervention on the conventional upholstery converts a regular backrest into two independent 'wraps' connected by colorful straps. A graphical aluminum structure frames the protagonist of this chair, the cushions.

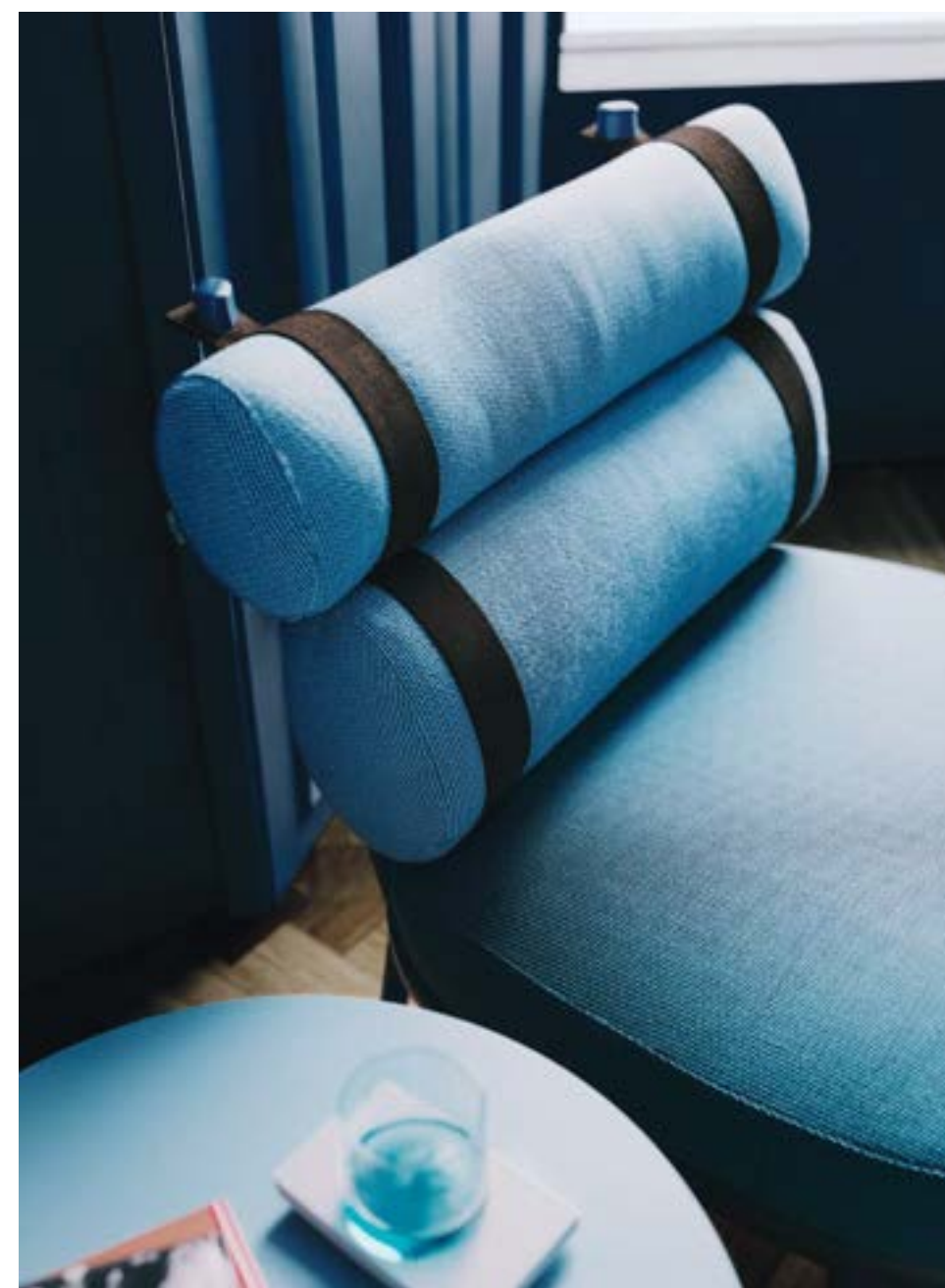



Roll





Dining Chair

KS2300100

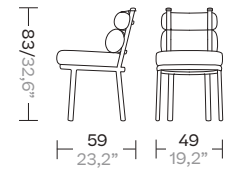

Club Chair

KS2300200

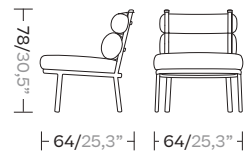

Bar Stool

KS2300300

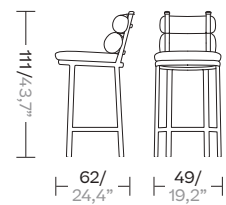

Dining Table ø135
& Dining Table ø80

ø135
KS2300500

ø80
KS2300400

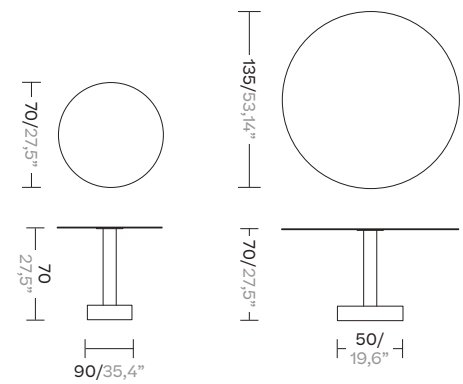

Centre Table ø135 and ø90

ø135
KS2300700

ø90
KS2300600

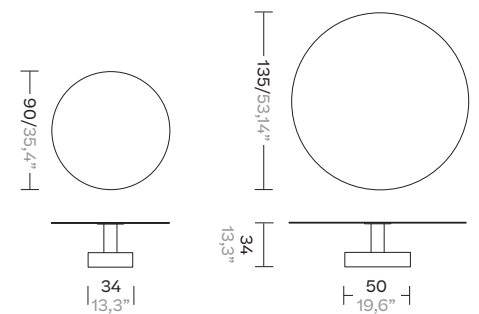

Side Tables ø48 and ø60

ø48
KS2300800

ø60
KS2300900

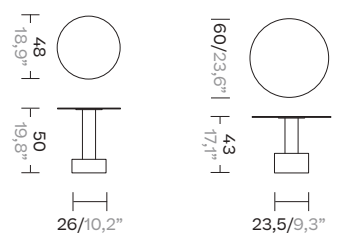

Mesh, by Patricia Urquiola

The Mesh collection recalls architectural facades, which filter the surrounding environment without stopping the light and air flow. Industrial and natural materials, hard and soft surfaces, transparent and solid volumes are put face to face in order to create this family of outdoor furniture based on contrasts.











3 Seater Sofa

KS1700100

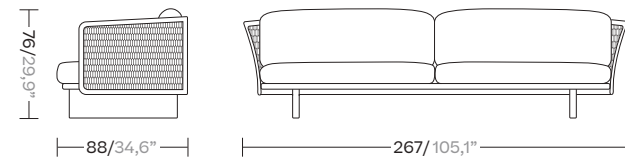

Daybed

KS1701000

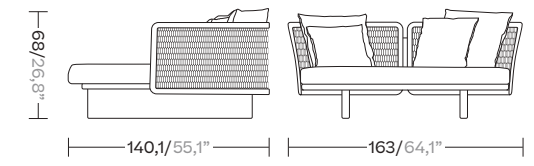

Left & Right Corner Module End

Left
KS1700400

Right
KS1700500

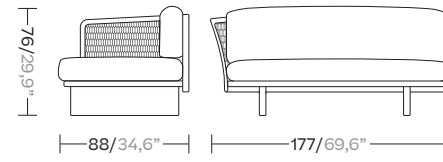

Right Deck Chair Module

Left
KS1701100

Right
KS1701200

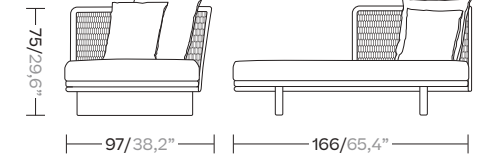

Left Corner Module Connection

Left
KS1700200

Right
KS1700300

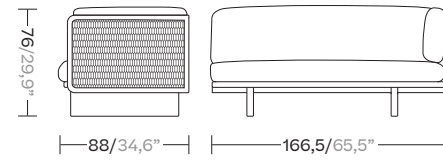

Deckchair

KS1700800

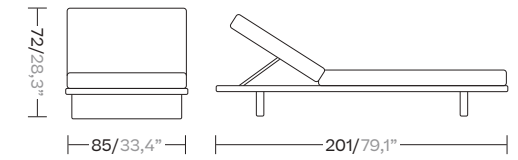

Central Module

KS1700600

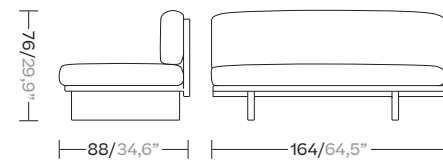

Two Places Deck Chair

KS1700900

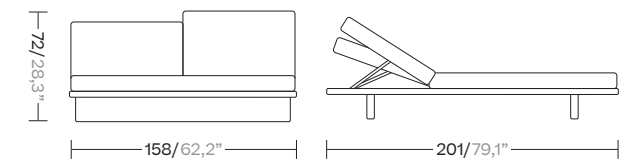



Bench

KS1700700

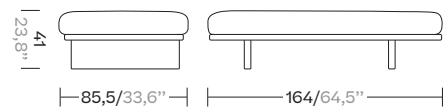

Centre Table ø90 ø135

ø90
KS1702200
ø135
KS1702300

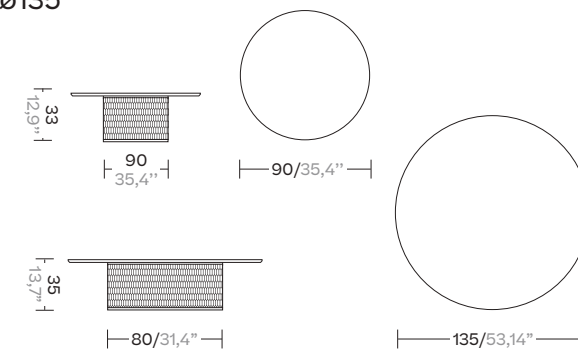

SideTable ø48 and ø60

ø48
KS1702000
ø60
KS1702100

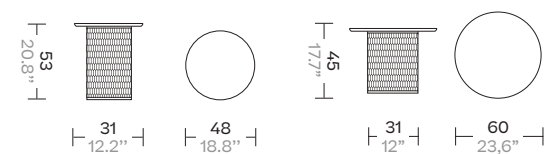

Dining Table ø180 ø135 ø90

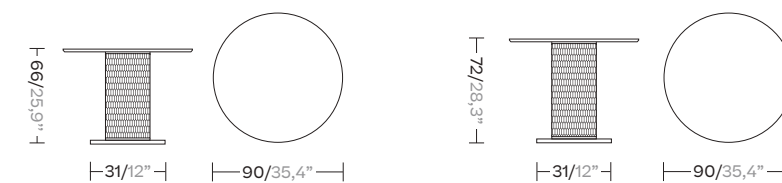

Low Dining Table
KS1701900

Dining Table
KS1701800

ø135
KS1701600

ø180
KS1701700

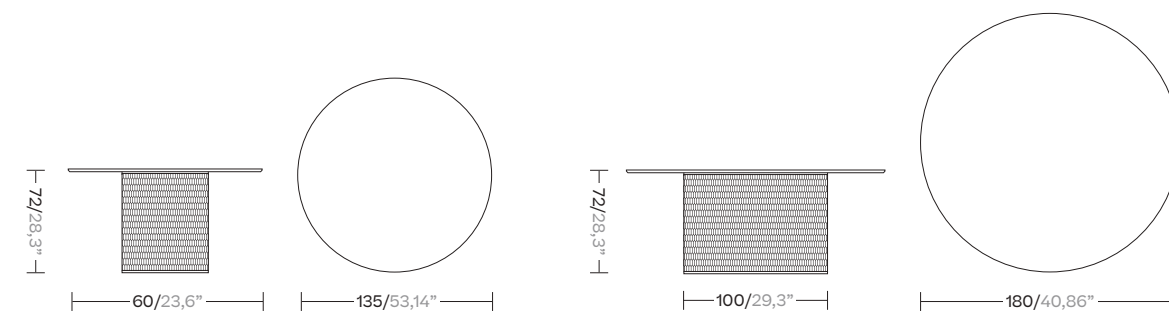

Basket, by Nanna and Jørgen Ditzel

An edit of the Basket chair, created in the 1950s by the Danish designers Nanna and Jørgen Ditzel. The Basket chair, made from oak, comes in its original version created by the Ditzels — hand-braided in wicker — and in an outdoor version made from artificial fiber and teak.





Basket



Indoor Club chair

KS1000200

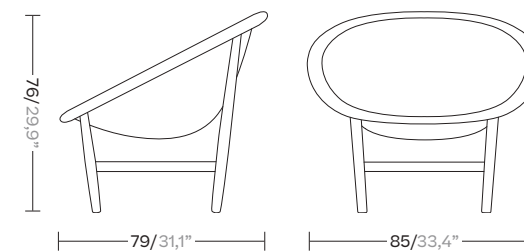

Outdoor Club Chair

KS1000100

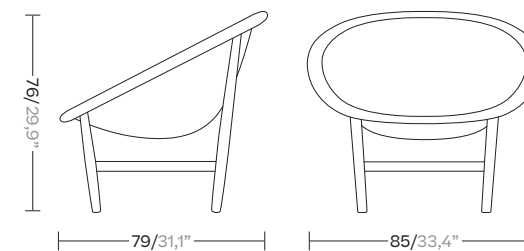

Bitta, by Rodolfo Dordoni

Grand Bitta is characterized by a combination of aluminum and teak legs, seats of braided polyester and comfortable cushions, with teak or stone table tops - all while using all waterproof materials. "The intention of the designer was to create dense braiding that would

still let the air through, reminiscent of the braiding of the ropes used to moor boats (hence the name Bitta, which means 'mooring' in Italian), which makes the pieces look lightweight but, at the same time, they look just like cozy nests in natural colors to sit back and relax in."















Club Armchair

KS7003000

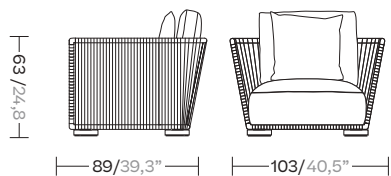

Central module

KS7003500

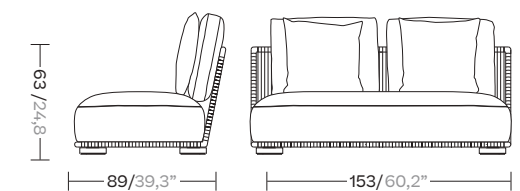

2-seater sofa

KS7003100

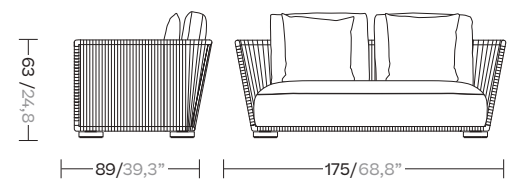

3-seater sofa

KS7003200

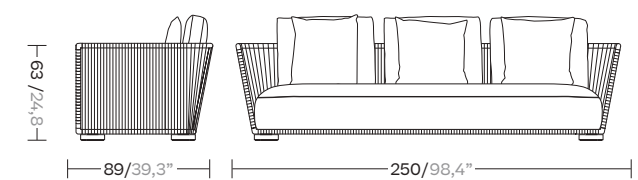

Left module

KS7003300

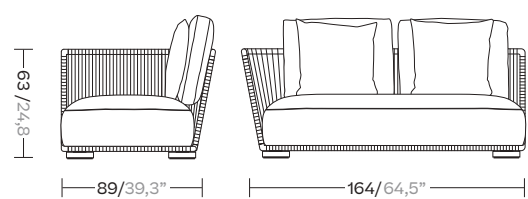

Centre Table

KS7002400

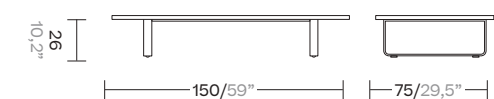

Right module

KS7003400

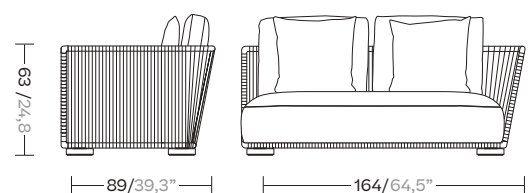



Dining Armchair Bela Rope

Aluminium legs
KS7000100

Teak legs
KS7000100

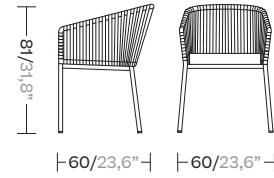

Club Armchair Bela Rope

Aluminium legs
KS7000300

Teak legs
KS7000300

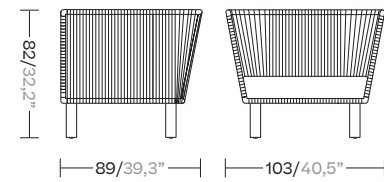

2 Seater Sofa Bela Rope

Aluminium legs
KS7001200

Teak legs
KS7001200

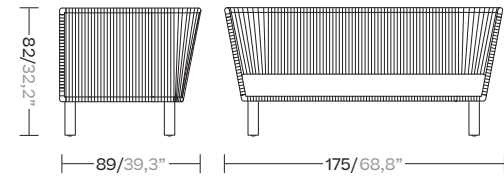

3-Seater Sofa Bela Rope

Aluminium legs
KS7001400

Teak legs
KS7001400

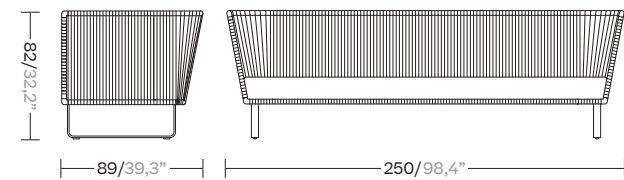

Left and right Corner Module

Left & Aluminium legs
KS7001600

Left & Teak legs
KS7001600

Right & Aluminium legs
KS7001800

Right & Teak legs
KS7001800

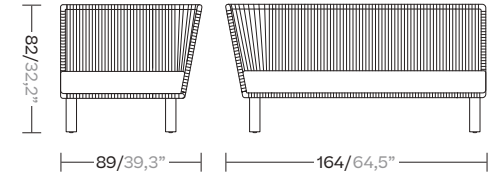

Central Module Bela Rope

Aluminium legs
KS7002000

Teak legs
KS7002000

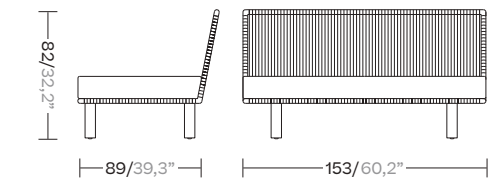

Bar Stool Bela Rope & Counter Height Bar Stool

Bar stool
KS7002600

Counter height Bar stool
KS7002800

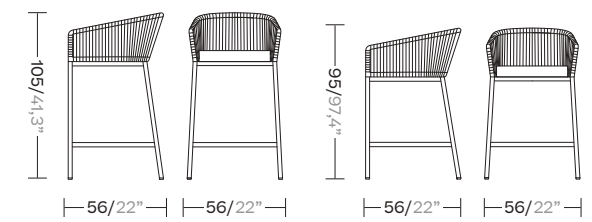

Deckchair Module

KS7000700

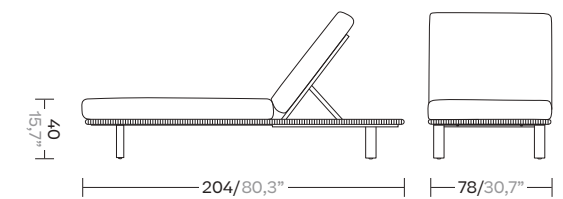



Deckchair Stool Module

Aluminium legs
KS7000600
Teak legs
KS7000600

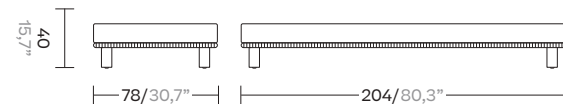

Daybed

Aluminium legs
KS7002200
Teak legs
KS7002200

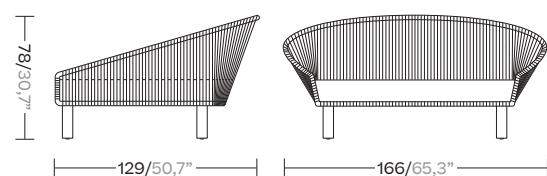

Club Swing Rope Set

KS7000800

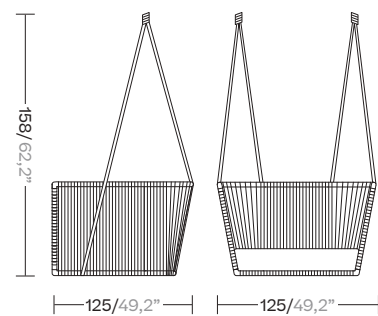

2 Seater Swing Rope Set

KS7000900

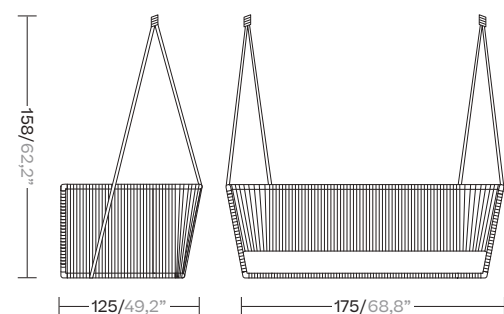



Dining Armchair

KS7L00100

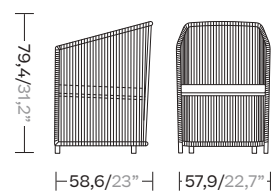

Daybed Rope & Parallel

KS7L00900

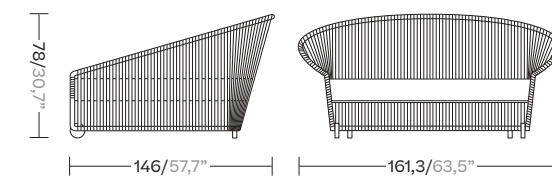

Club Armchair Rope & Parallel

KS7L00300

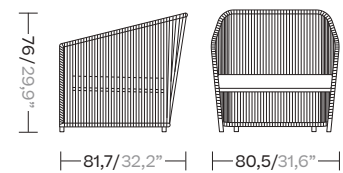

Centre Table

KS7002400



2-Seater Sofa Rope & Parallel

KS7L00500

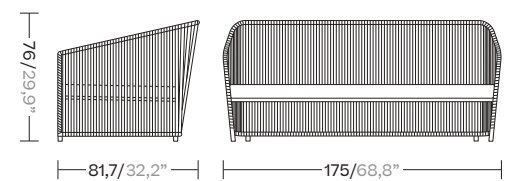

Dining Table Extendable 8-12 Guests

KS7002500

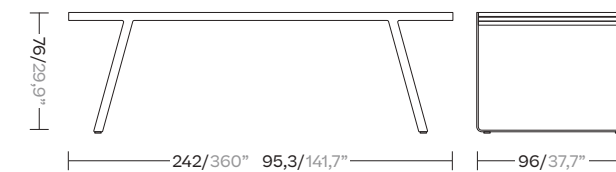

3-Seater Rope & Parallel

KS7L00700

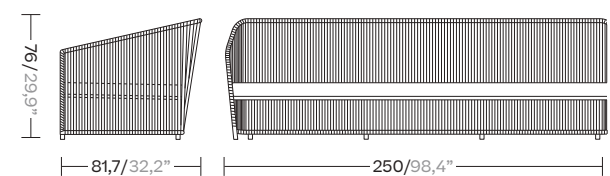

Maia, by Patricia Urquiola

Like an architecture that is in keeping with its surroundings, the Mala collection designed has a natural lightness and elegance. The design of the artisan braiding, the sturdiness of the aluminum frame and the new, Porotex and chenille fabric collection create a combination that oozes energy.









Dining Armchair

Aluminum legs
KS6500100

Teak legs
KS6500200

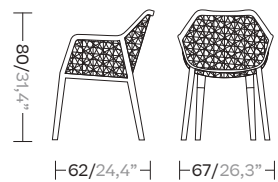

Club Chair & Footstool

Aluminum legs
KS6500300

Teak legs
KS6500400

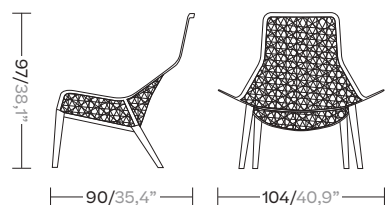

Egg Swing

KS6500900

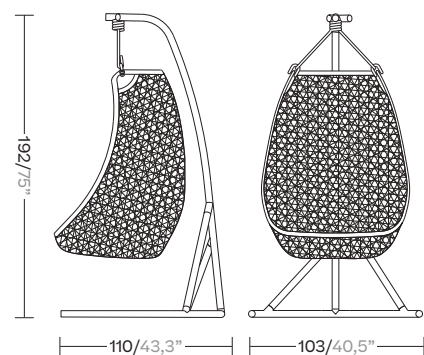

Barstool

KS6500800

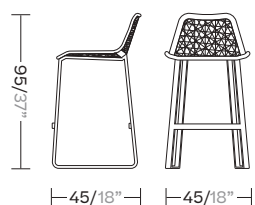

Side Table

Ø48
KS4101800/ KS4101900

Ø60
KS4101600/ KS4101700

Centre table
KS4101400/ KS4101500

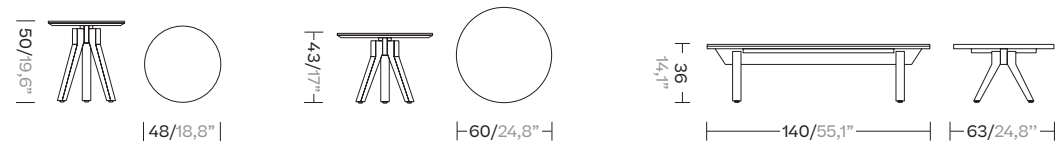

Dining Table

Ø135
KS4102100/ KS4102200

4 guests
KS4102000

6 guests
KS4102300/ KS4102400

8 guests
KS4102500/ KS4102600

10 guests
KS4102700/ KS4102800

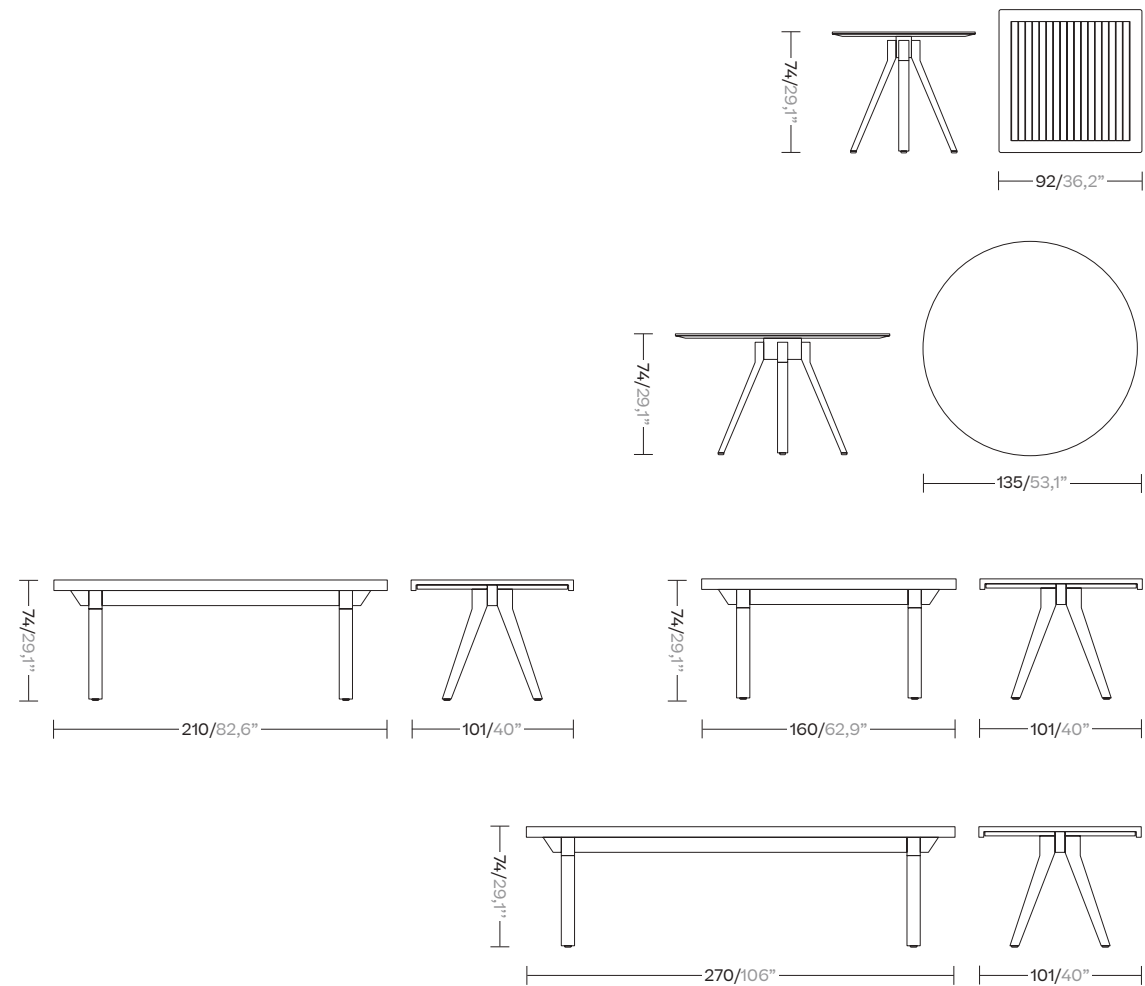

Bar Table

KS4101300

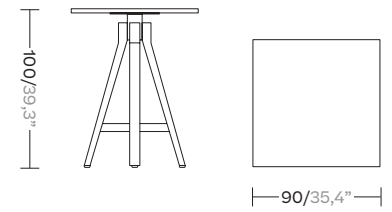

Park Life, by Jasper Morisson

Park Life is a complete family of furniture for outdoors, whose clean cut profile is adaptable to a wide range of situations. Lightweight, yet extremely durable, it is easily stacked for transport or winter storage. With technical sophistication, careful ergonomics and pleasing looks, Park Life offers a long life both structurally and visually.

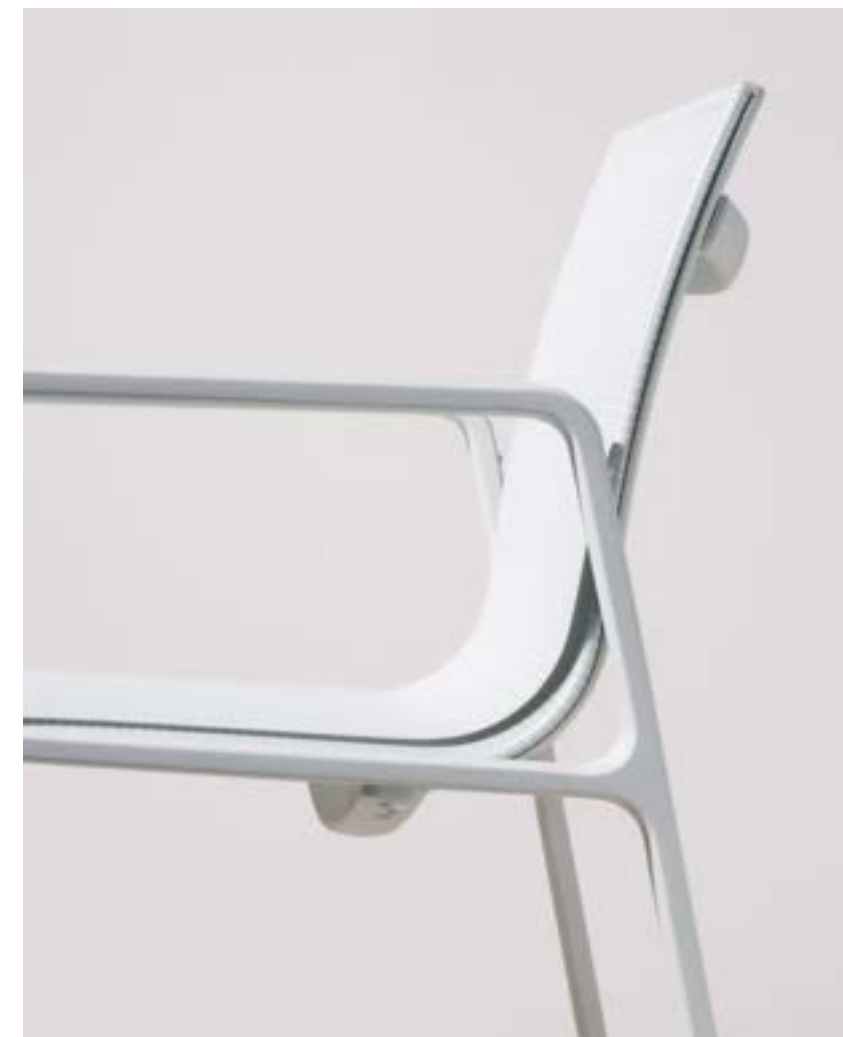









Club Armchair

KS1100600

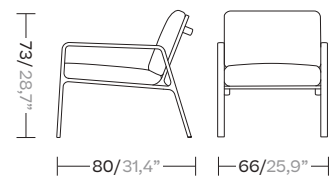

Dining Armchair

KS1100100

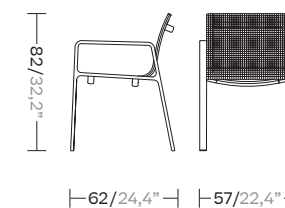

2 Seater Sofa

KS1100700

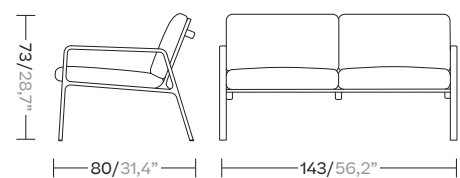

Low Dining Armchair

KS1100500

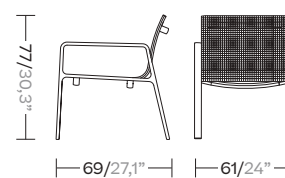

3 Seater Sofa

KS1100800

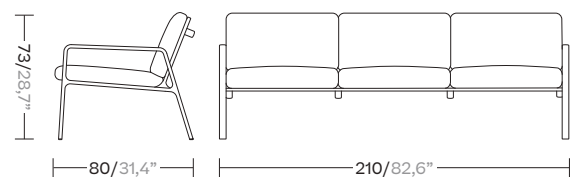

Low Dining Table 220x94 / 8 guests

KS1100400

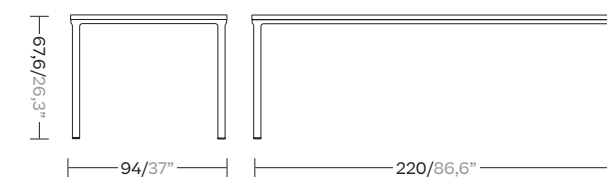

Deckchair

KS1101500

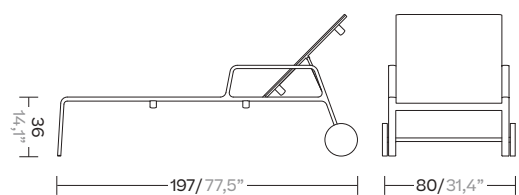

Low Dining Table 160x94 / 6 guests

KS1100300

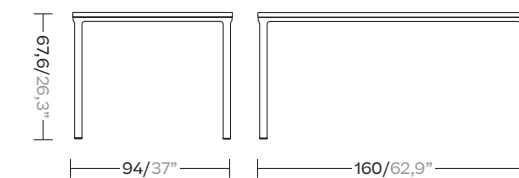



Low Dining Table 94x94

KS1100200

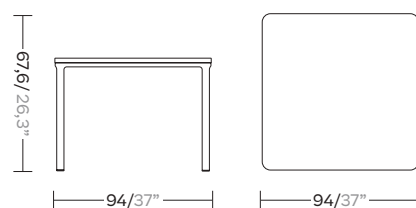

Centre Table 120x120

KS1100900

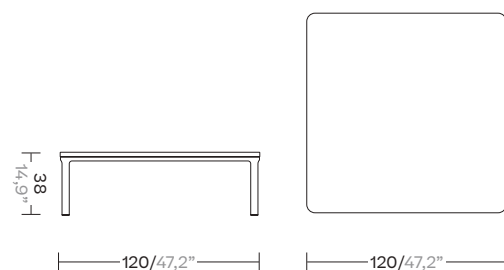

Centre Table 120x60

KS1101000

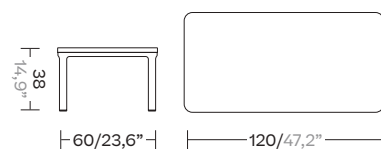

Side Table 50x50

KS1101100

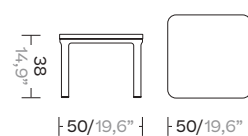

Landscape, by Kettal Studio

Landscape aims to be part of a project. It is not understood as an item apart, but instead relates to its environment and melds with it. It is the project that is important, not the product, and this is its essence. Its rationalist construction seeks to bring order, form and structure to the outdoor space. Functionally, it is designed to provide shelter: to shade and cool or protect from the elements.











Club Armchair L

KS9400400

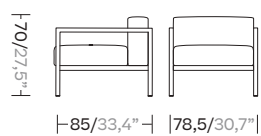

3 Seaters Sofa XL

KS9400900

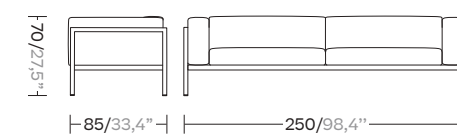

Left & Right Corner Module

Left
KS9401000

Right
KS9401100

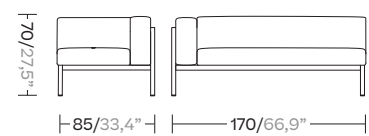

3 Seaters Sofa XL

KS9401200

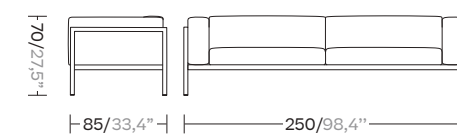

Island

KS9401300

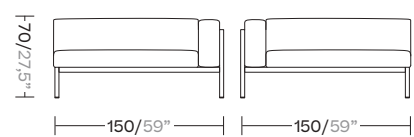

Dining Armchair

KS9400100

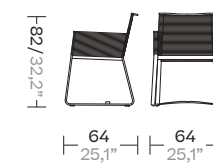

2 Seater L

KS9400700

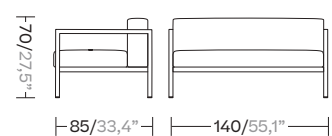

Rocking Chair

KS94003000





Single Lounger

KS9401500

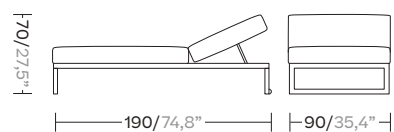

Double Lounger

KS9401600

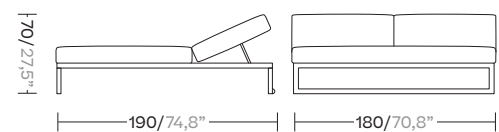

Deckchair

KS9401800

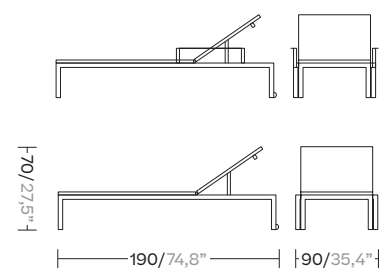

Double Deckchair

KS9402100

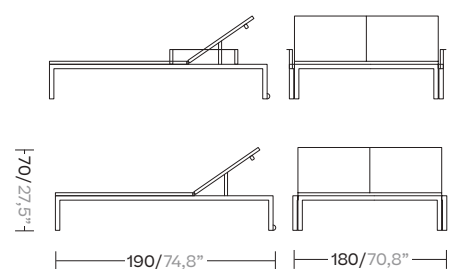

Transat

KS9401700

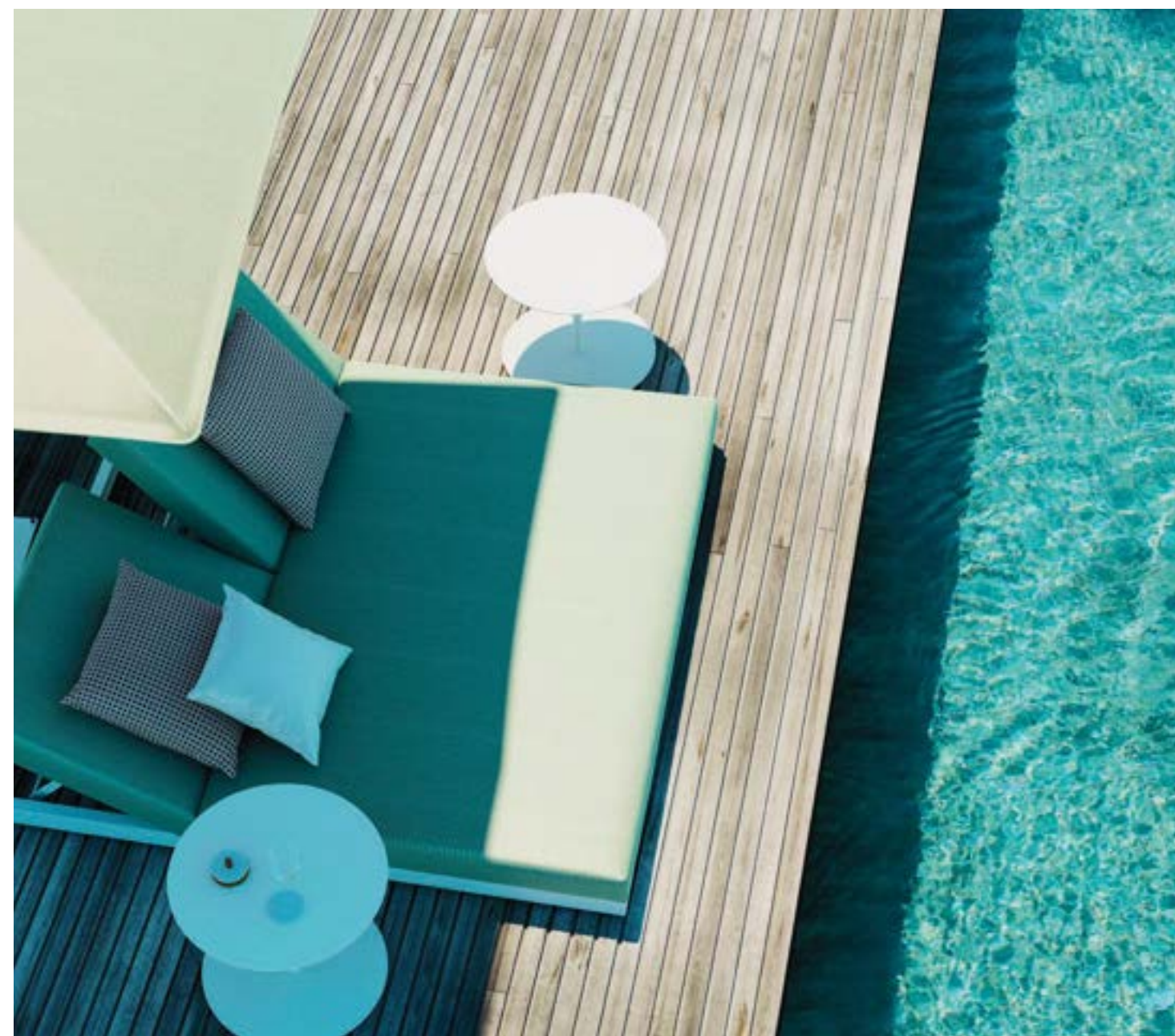
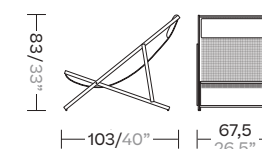

Dining Tables

8 guests
KS9402500

12 guests
KS9402600

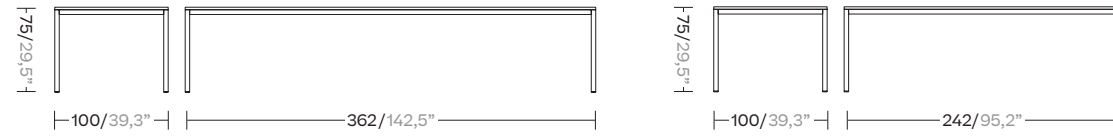

Extendable Tables

6-10 guests
KS9402700

8-12 guests
KS9402800

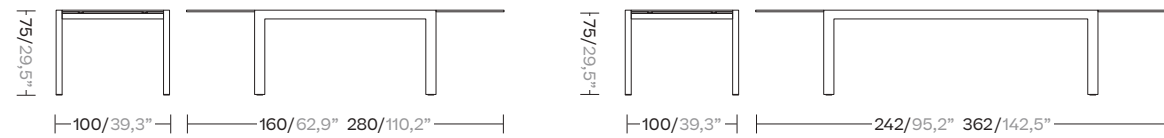

Center Tables

Centre Table
KS9402900

Aluminium Side Table
KS9402300

Teak Side Table
KS9402400

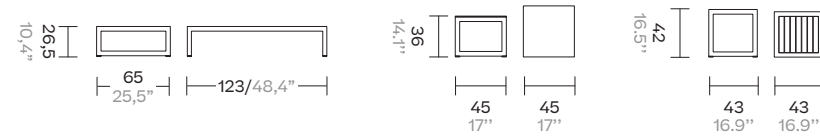

Net, by Kettal Studio

The Net collection conserves a classic structure. Elegant with smooth lines, it gives a calming and attractive appearance. Woven cords, aluminum and tubing come together to provide a light, handcrafted look.







Dining Armchair & Lite Dining Armchair

Dining
KS6800100

Lite
KS6800200

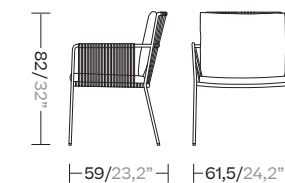

Club Armchair & Lite Club Armchair

Club
KS6800900

Lite
KS6801000

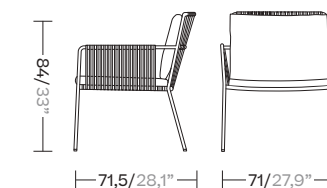

Dining Table

KS6800500

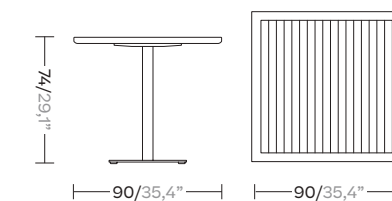

Bar Table

KS6800600

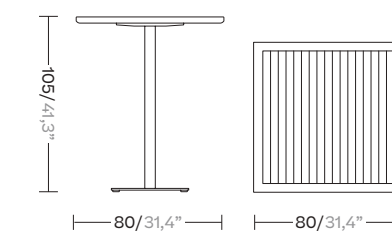

Village, by Jasper Morrison

A chair for all outdoor situations, from village house to grand café. The lightweight aluminium structure allows easy handling while the neutral language of its form takes nothing away from the scenery. This chair pays respect to the long standing codes of metal stacking outdoor chairs while gently refreshing the look.



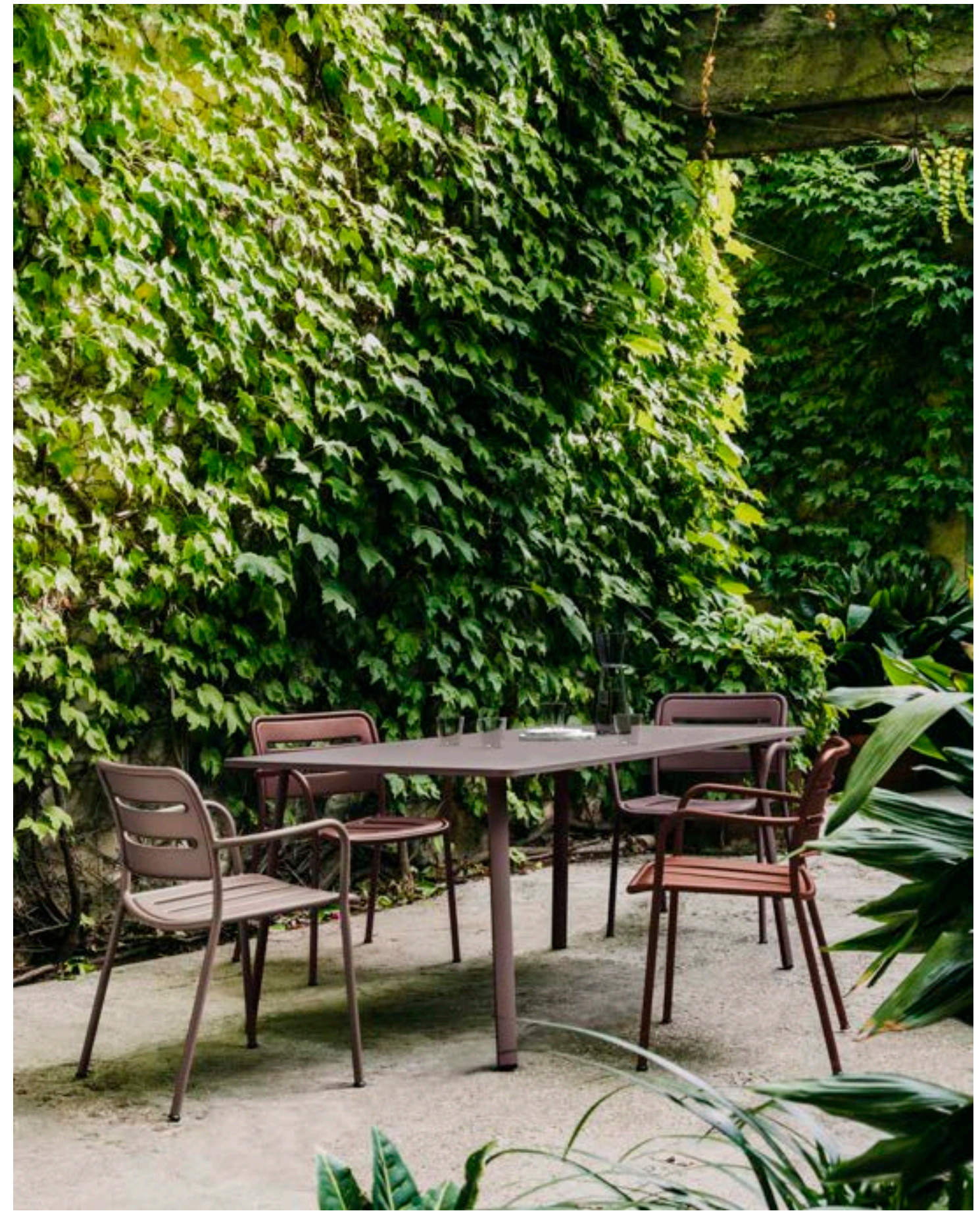



Dining Armchair

KS1300100

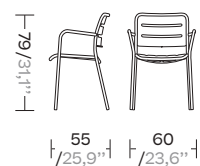

Dining Table 220x94

KS1300600

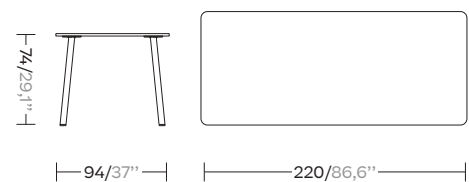

Dining Table 160x94

KS1300500

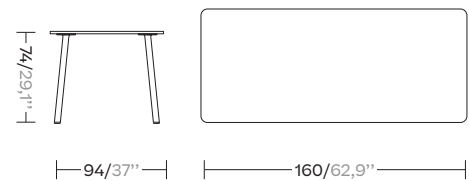

Dining Table 94x94

KS1300300

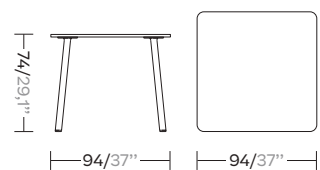

Dining Table D135

KS1300400

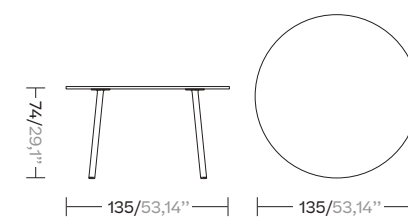

Lighting

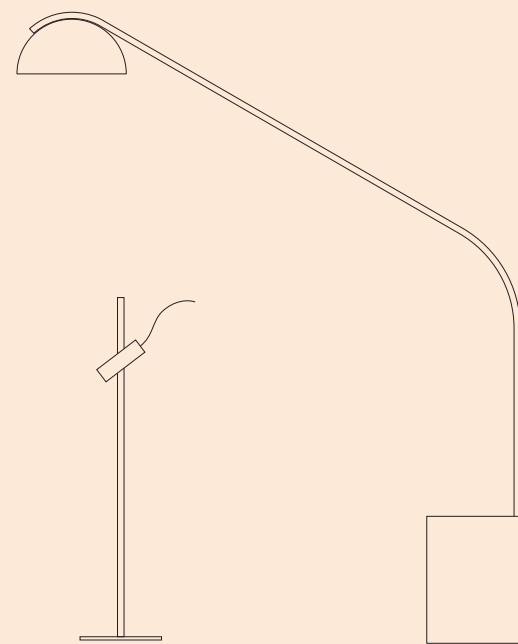
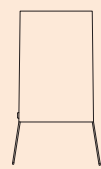
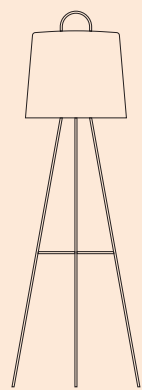
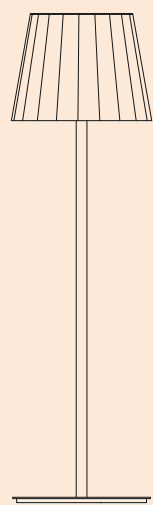
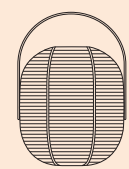

Elegance and technology meet to improve the lighting of your spaces.

The different light designs can adapt to all situations: conversation, concentration, relaxation and more. We now know that an adequate amount of light and a clever placement improves mood and energy levels. Form, function and performance is driving the fusion of technology and emotion.

Half Dome, by Naoto Fukasawa



Half Dome

Never the same Half Dome, never the same light or the same mood. Half Dome is a great mountain with endless variations of lighting and sky situations and seasonal characteristics; the many images reflect the varied creative responses to this remarkable granite monolith. The dimension of Half Dome light follows our image of the moonlight.



Bela lamp, by Doshi Levien

Bela is a colorful and versatile lamp with a continuous length of rope in a form referencing the texture and lightness of traditional handwoven lanterns. Every year in India there is a kite festival and the streets are lined with enormous spinning frames wound with colourful kite string. These light wooden structures gave Doshi Levien the idea for the frames or spools onto which the Bela ropes are clipped. It can be placed directly on the floor, suspended or used as a standing lamp.



Dots, by Kettal Studio

Dots lamps, manufactured in aluminium with LED lights, are available in two versions: floor lamp with a circular base and planter lamp with a base that can be fastened to the ground. The new Dots lamps have been developed for indoor and outdoor use. The height and direction can be adjusted to focus the light where it is needed. The lamp features a waterproof switch and includes a USA plug.

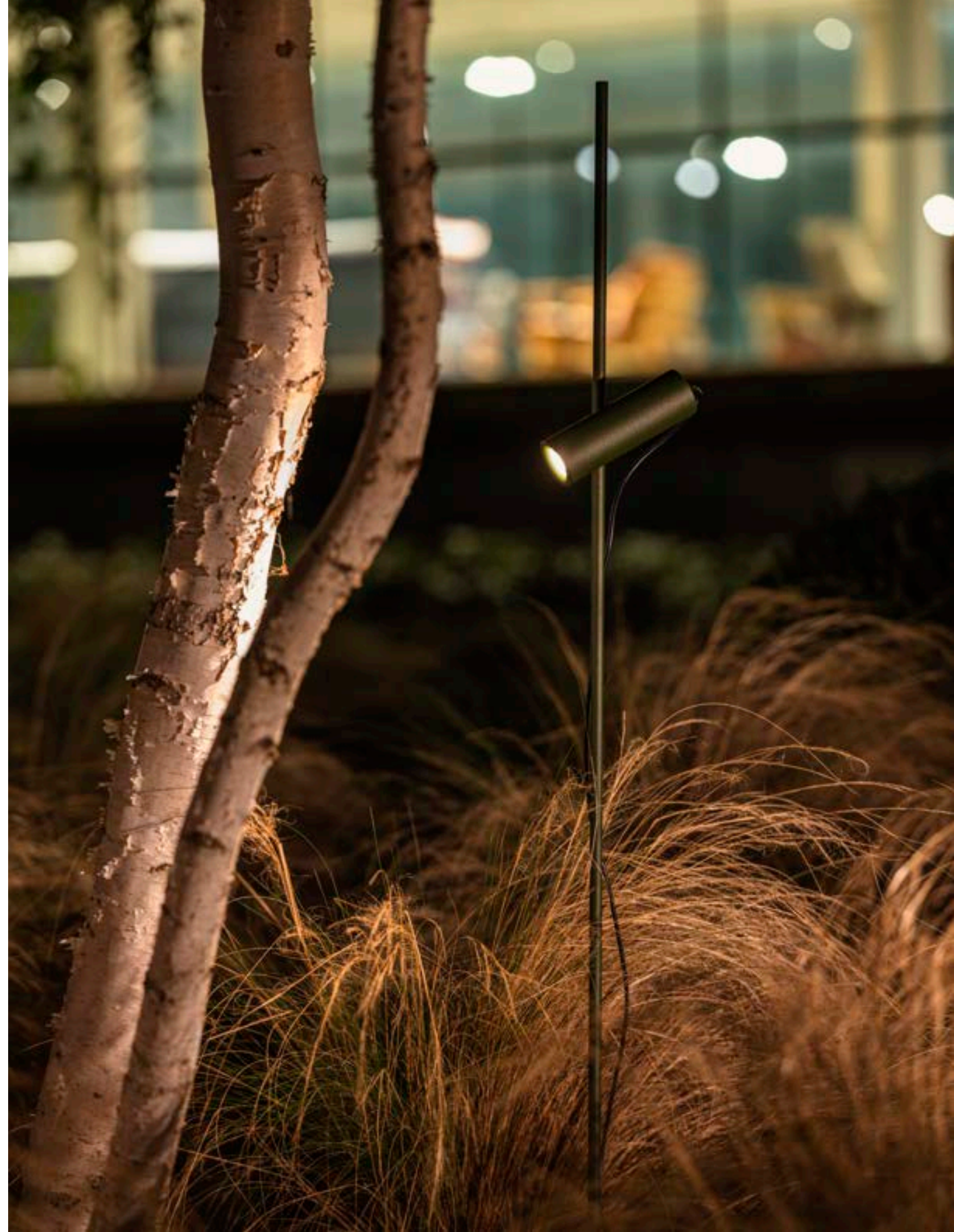

Mia, by Michel Charlot

Mia is a family of nomadic lamps built around an acid-treated glass diffuser which is protected by a large polypropylene lampshade. Both are held in place by a clever wire structure. It was important to have the lamps completely waterproof. By achieving this, the Mia allows for a wide range of applications and it is suitable for outdoor use. The Mia series comprises multiple variations, including a small battery powered lamp.





Overhang Lamp

KS5700200

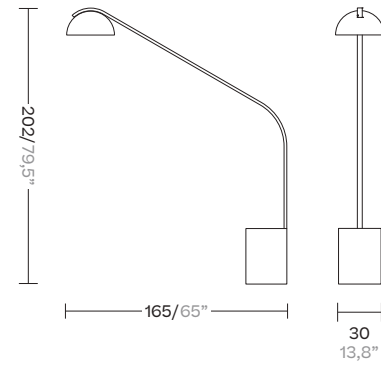

Floor Lamp

KS5700100

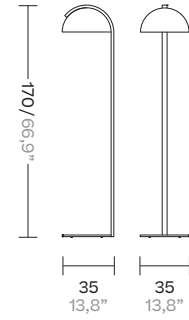

Bela Lamp & Bela Lamp Floor

KS5700400
KS5700300

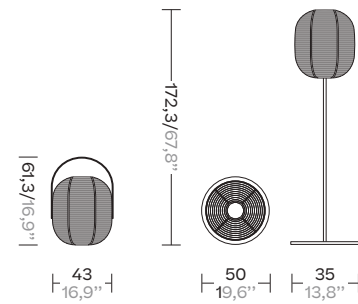

Dots Outdoor Floor Lamp & LED Aluminium Planter light

KS5700600
KS5700500

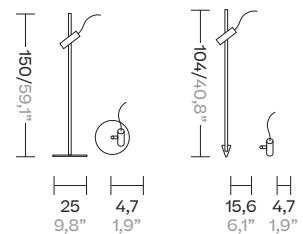

Mia Lamp Outdoor Floor Lamp

KS5700800

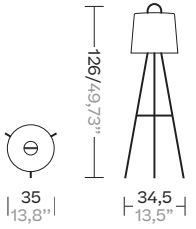

Mia Table Lamp Manganese S & L

KS5700900

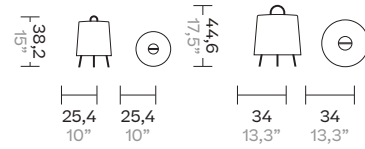

Floor Lamp

KS5700700

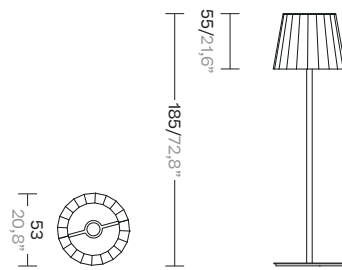

Shadow

Selectively shade your outdoor spaces.

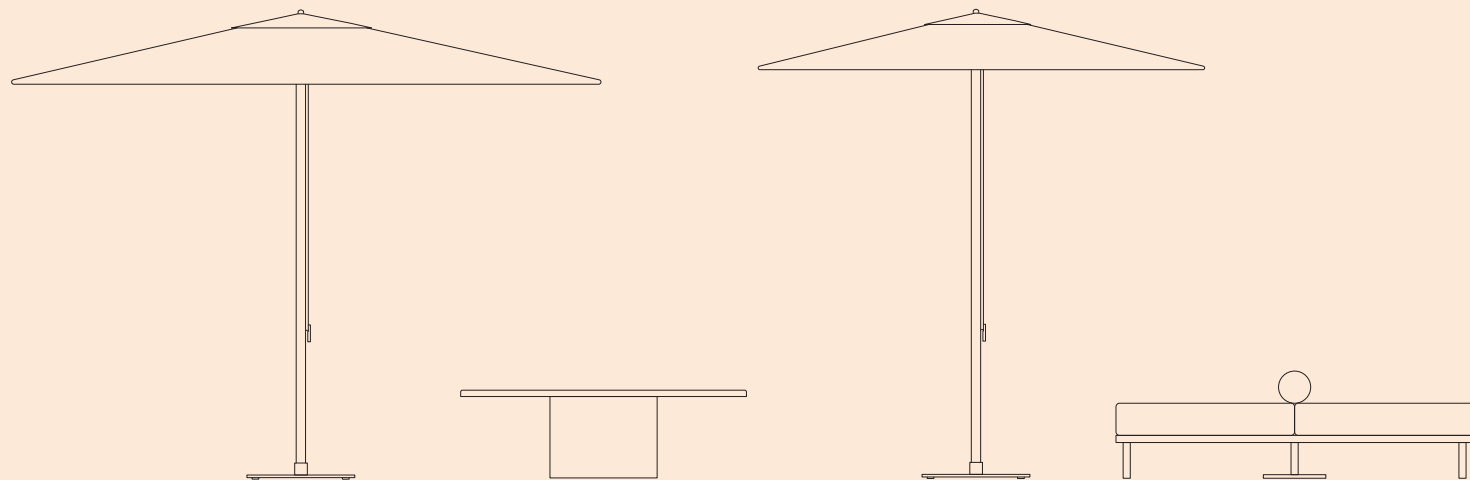

The humble parasol has a vital role to play in maximizing your enjoyment of outdoor spaces. It ushers away the harsh sunlight and it should be an unassuming but elegant presence on the patio.



Paladin, by Konstantin Grcic

Paladin is a wooden parasol for domestic and public use. Its canopy appears to be floating on top of an elegantly shaped mast. The design employs a mechanical principle which incorporates the tension of the canopy into its structural logic. With only the mast and four movable struts, the textile absorbs the tensile forces of the parasol when unfolded. The mast goes right through the center of the canopy,

leaving a central hole that is acting as an indirect skylight and allowing for air circulation. The wooden elements are made in natural teak with a reinforcing core in aluminium. The mechanical joints and fasteners in aluminium and stainless steel are designed to minimize the material input while offering maximum performance.



Paladin

KSB100100

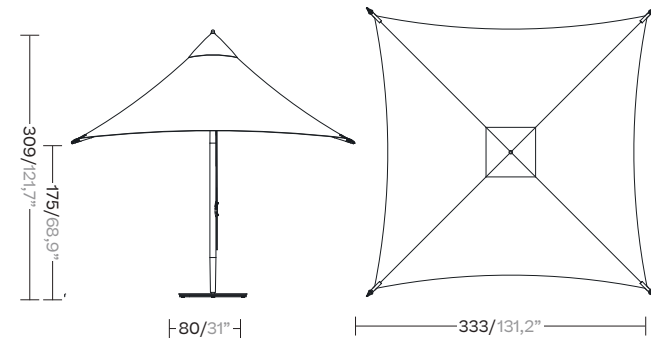

Meteo S, by Konstantin Grcic

Meteo aims to explore the largely untapped design potential of modern parasols. Protection from direct sunlight is becoming a quintessential condition for our health and wellbeing. The increasing impact of parasols and other sunshade systems on the planning and furnishing of modern cityscapes, recreational resorts and private dwellings gives rise to the challenge of a renewed approach to this specialized product category.

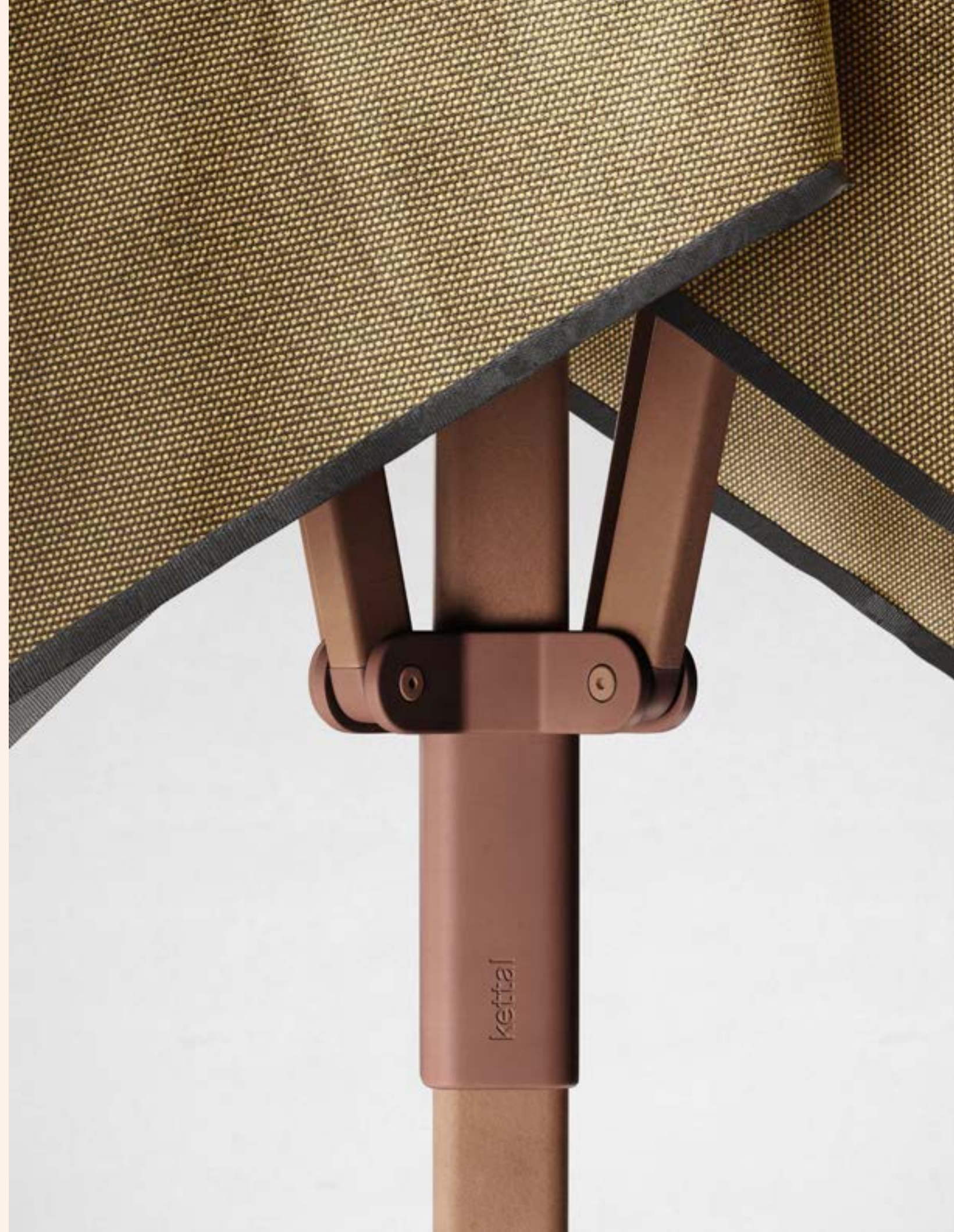



Meteo L







S Parasol

KS5705800

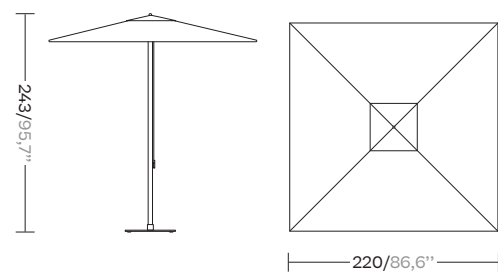

Daybed Base Parasol

KS5703000*

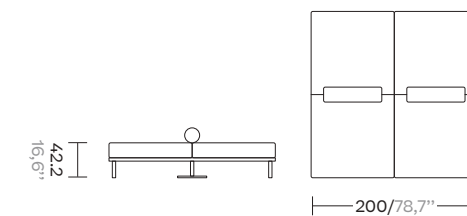

S Meteo Parasol Steel Flat Base (No wheels)

KS5706000

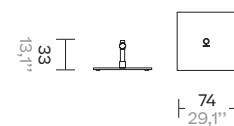

Steel Centre Table Base Parasol

KS5703000*

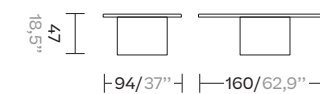

L Meteo Parasol

KS5702700

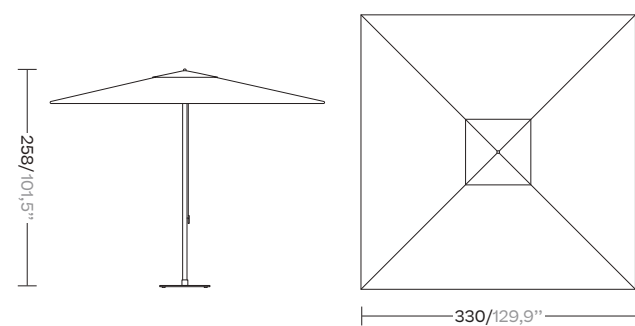

Steel Planter Base Parasol

KS5703100*

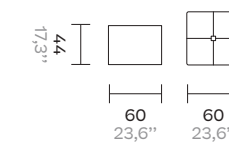

L Meteo Telescopic Steel Flat Base (With wheels)
L Meteo Telescopic Concrete Base (With wheel)

L Meteo Telescopic Steel Flat Base
KS5706200
L Meteo Telescopic Concrete Base
KS5706300

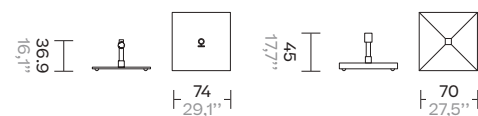

Objects

Offering additional options while complementing the collections.

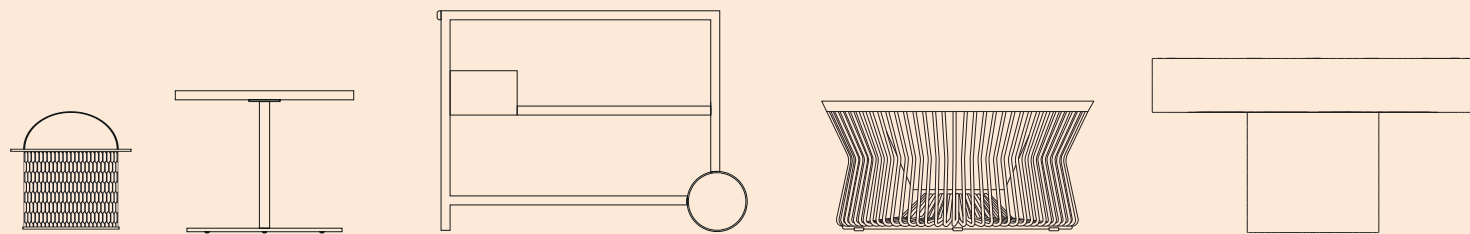

A selection of objects that complement indoor and outdoor spaces. They will dovetail aesthetically and functionally with your overall project.

Superfan by Michael Anastassiades

Superfan is a tri-blade fan whose geometry is simply defined through three angled blades, meeting at the rotating axis. All design decisions are made to maximise performance and improve efficiency: the angle of the blades, the lightness of the aluminium material and the selection of the motor for accurate speed control and quiet function.

The two fan versions operate with equal efficiency both with and without a pendant, offering flexibility of use for different ceiling heights.



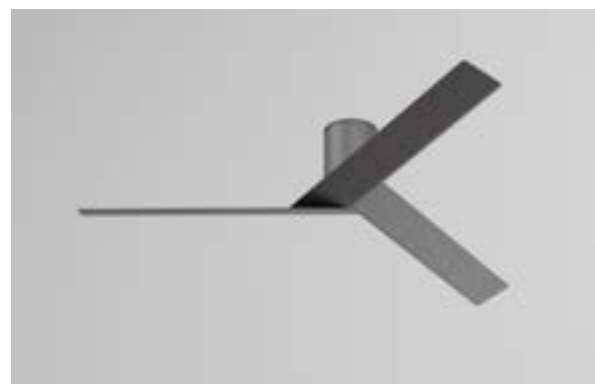

Ceiling fan

KSA900100

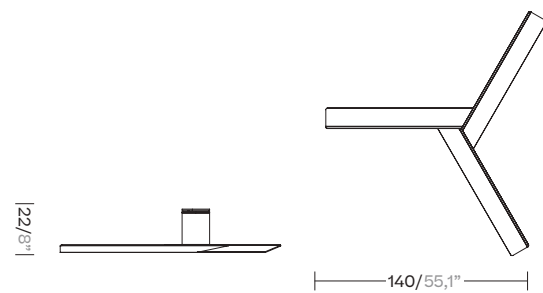

Ceiling fan downrod

KSA900200

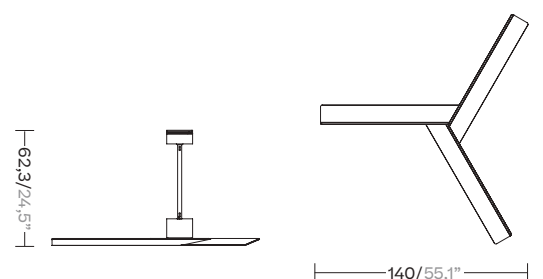



Base Kitchen by Kettal Studio

This modular kitchen structure offers infinite solutions. An aluminium supporting frame can be teamed with a number of stoneware modules in various combinations whilst maintaining its authentic linear design. This design features clean, smooth surfaces, with no corners, for easy cleaning and maintenance.

It is available in two types of stoneware and two Iroko wood finishes for the doors. The modular aluminium structure comes in black only. Along with basic kitchen functions, it has a gas barbecue and can include several burners with a support for a wok. It can also include a bar.







Cook module



A6800GAS2Q 2 gas cooker

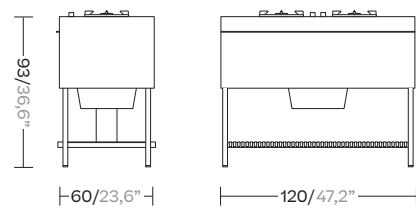

Barbaque module



A6800BBQFL Flat lid barbaque
A6800BBQHL High lid Barbaque

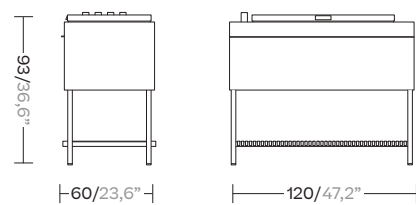

Sink module



A6800AGU0D

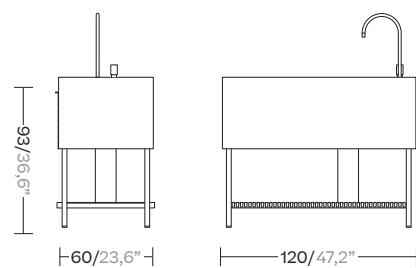

Work top module

A6800ENC00

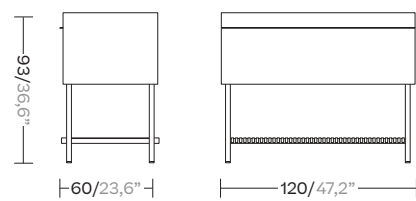

Work top + kitchen bar

A6800ENCKB

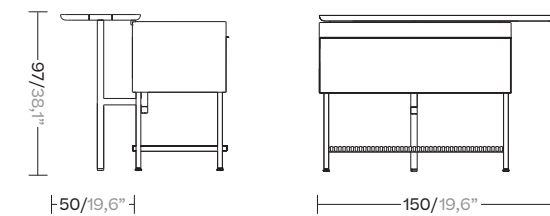

Fridge Module

KSA602230

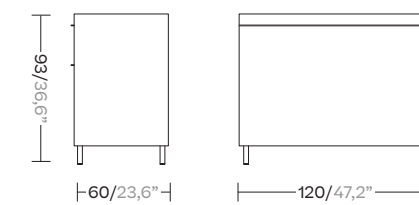

Sink top + Work top +
Cook top 2 configuration

KSA604800

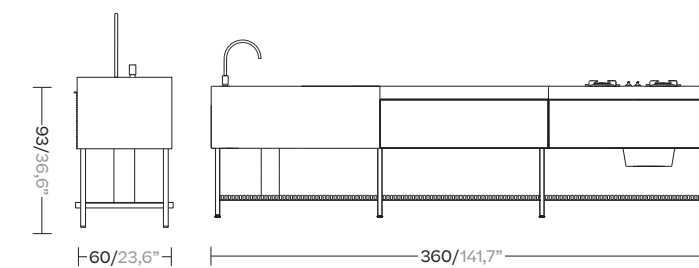

Sink top + Work top + Cook top +
Barbaque configuration

KSA605400

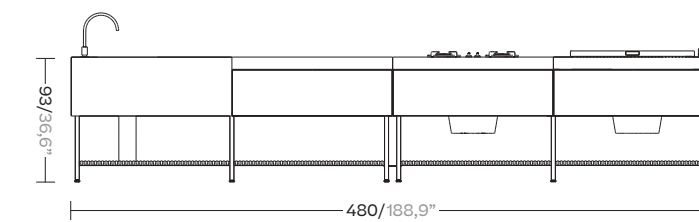



Outdoor Kitchen

KS5702100

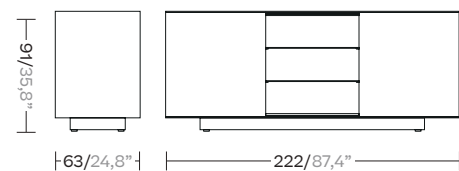

Trolley

KS5702200

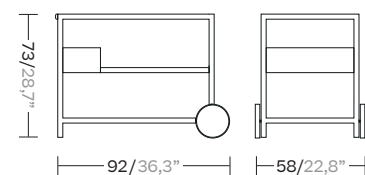

Sideboard

KS5702000

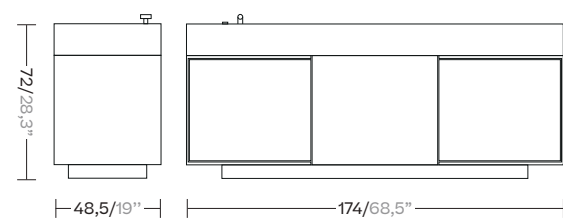





Rug

KS5702300

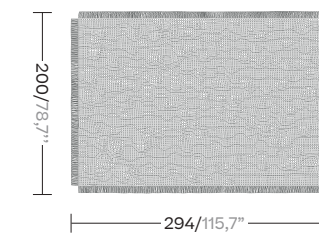

Block Fabrics Rugs

KS5702400

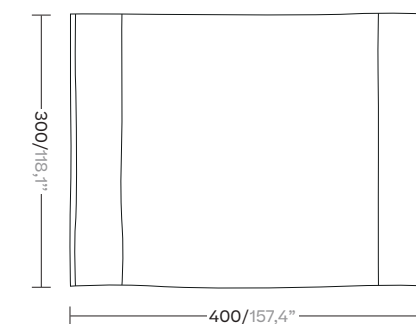

Line Fabrics Rugs

KS5702500

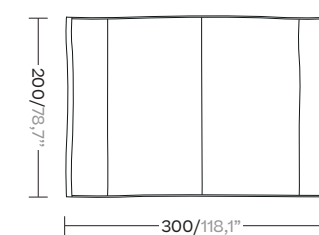



ZigZag Large & Medium Planter

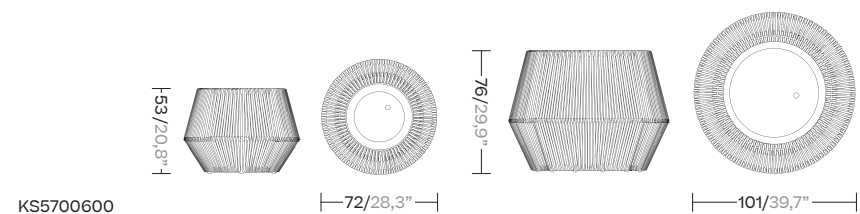

KS5700600



ZigZag Pouf & High Pouf

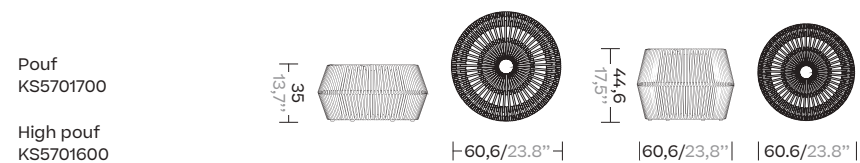

Pouf
KS5701700

High pouf
KS5701600



Fire Pit

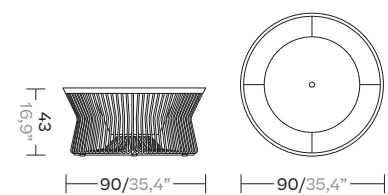

KS5701700



Side Table + Tray

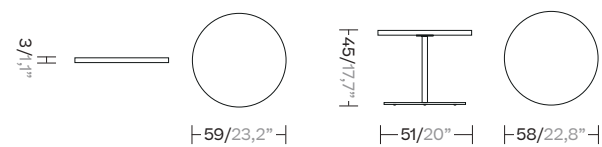

KS5701900



Totto Small, Medium, Large

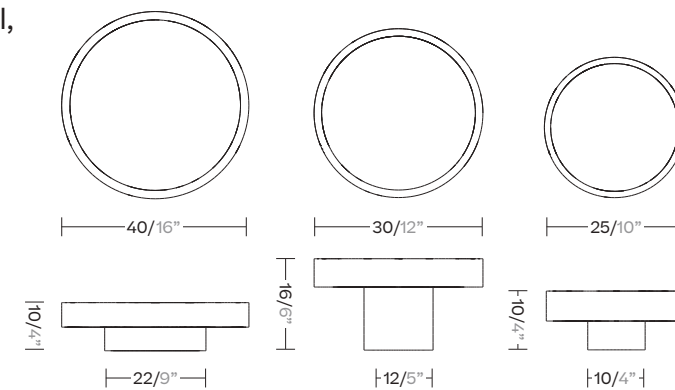

57ATR-952-41-...
57ATR-952-42-...
57ATR-952-43-...

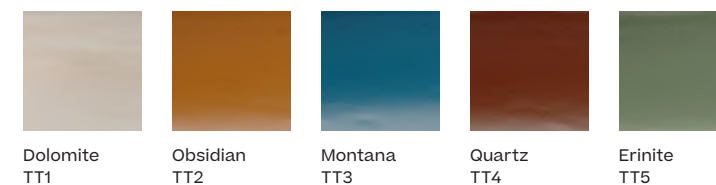

Ecological awareness

Choosing materials
—being a large business comes with
large responsibilities

Choosing materials for us is about making responsible decisions. When we're not able to use renewable resources, we aim for recycled or recyclable ones.

Ecological awareness. To buy responsibly means to keep for a longer time.

For us at Kettal, ecology is not marketing. It's a very serious matter. We have analyzed the variants of product life cycle to minimize environmental impact as far as possible. Not only in our raw material usage, but also other variables such as CO2 emissions from transport or use and durability.

Raw materials: Not only are they recyclable but also recycled. We study the impact of the material over time. There is no point using a very ecological material if, due to its construction, it needs to be replaced many times during the product's life cycle, thus multiplying the pollution caused by its production process.

Okm production: Trying to produce all components close to our Kettal production center in Barcelona is one of the brand's objectives to reduce CO2. The essential raw materials used at Kettal, such as fabric, rope and aluminum, are produced within a radius of 100km.

Use and durability: We do not build in obsolescence. Each design is aesthetically designed and technically developed to last as long as possible. The longer a product lasts, the less often it has to be replaced and therefore the fewer production processes that have to be carried out.

Accordingly, we at Kettal keep technical drawings and product patterns that are 30 years old in order to be able to replace components and extend the life of the product.



Kettal is developing and manufacturing in Europe with a straight focus on the LEED standard requirements. Kettal Quality & Certification management team is

coordinating the LEED Certification process with an external LEED specialist consultant.



Selection of local partners and suppliers (Short Distance Supply Chain).



Selection of long life cycle manufacturing components and techniques (Aluminum, coating, fabrics, foams, secured glass).



Selection of environmental certified materials (OekoTEX, EPD, FSC).



Selection of recycled and/or recycled materials (Recycled aluminum, recycled foam, recycled fabric).



Recycled & Recyclable

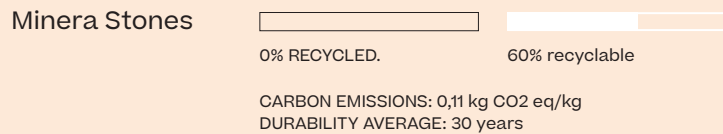
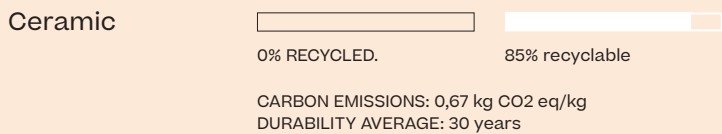
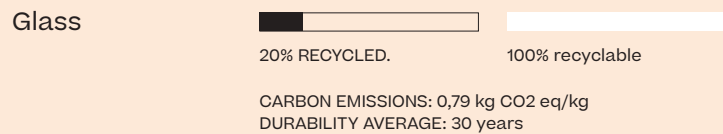
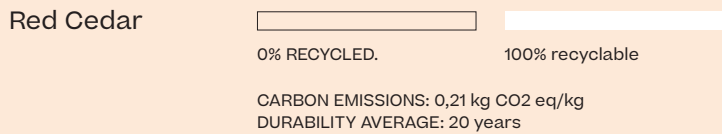
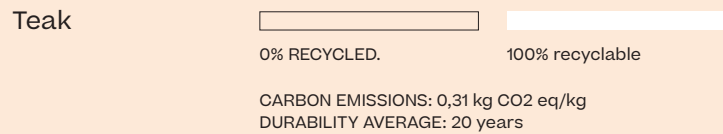
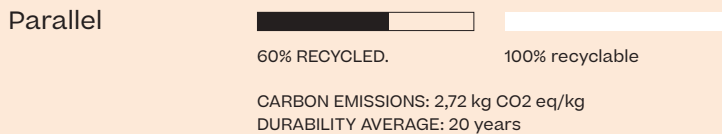
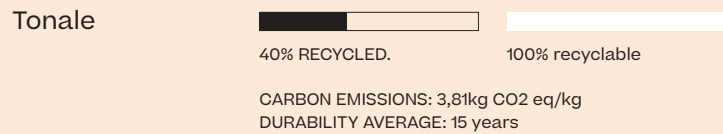
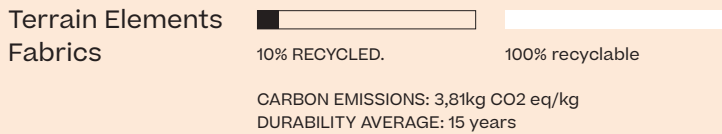
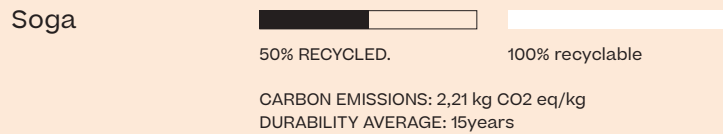
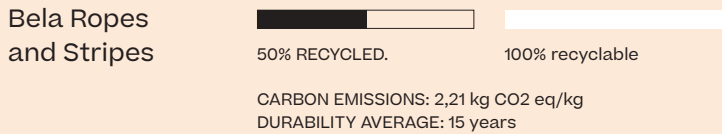
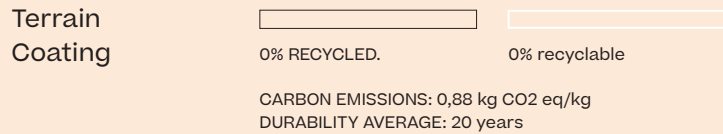
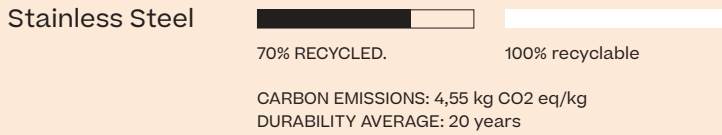
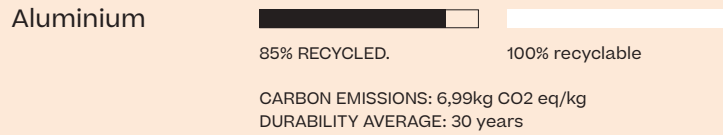

(recommended materials)

Life cycle analysis

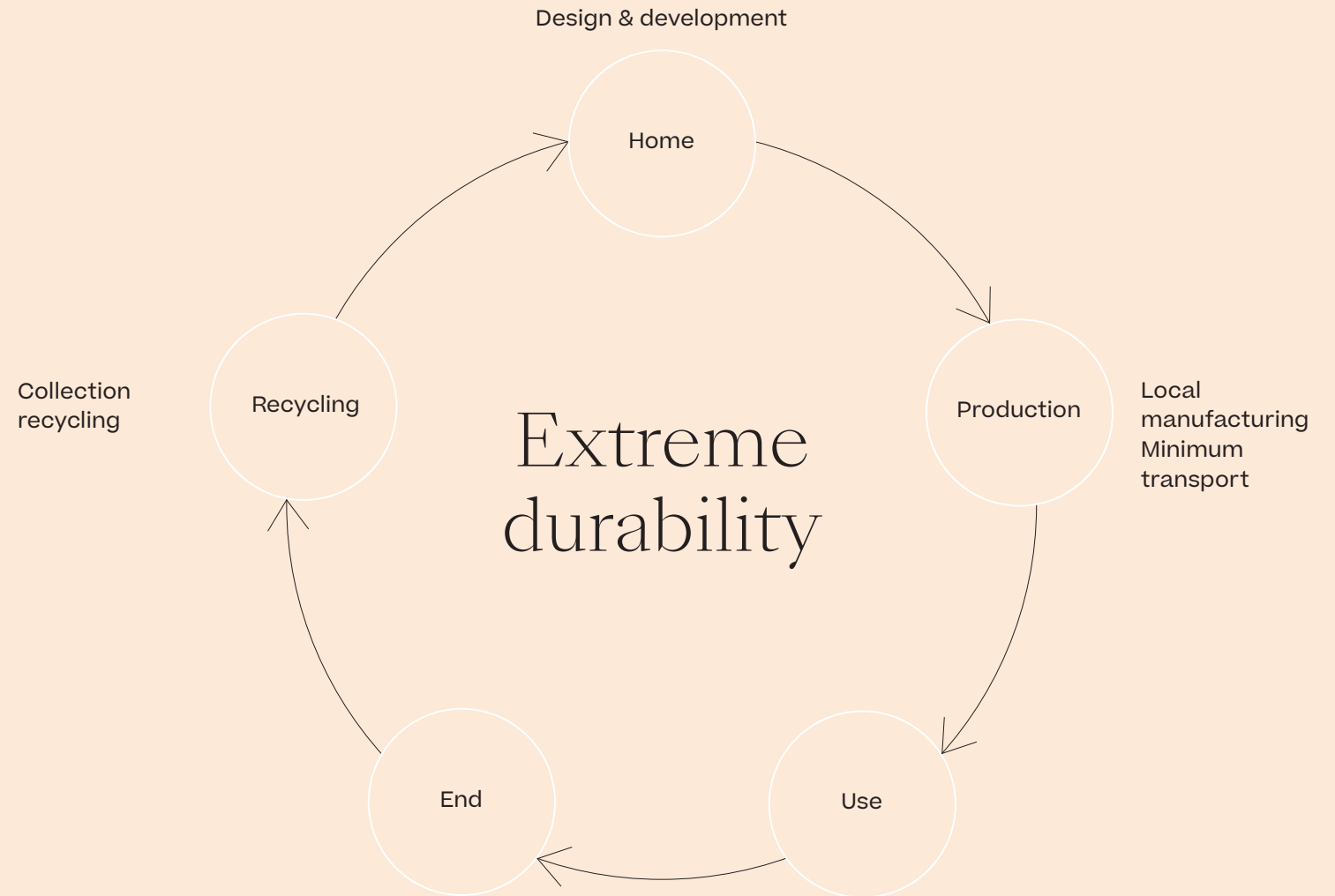

Finishes

Contemporary & elegant finishes
for endless combinations.

The wide selections of materials include fabrics, metals, woods, stones and ceramics. All of these worlds form the basis of the library. We invite the professional to explore and combine colors, textures and materials to create exclusive codes for each project.

Terrain Elements*



L: Laminate
T: No laminate (only for umbrellas)

*Available March 2023



Terrain Fabrics Laminate



Tonale Boucle Laminate



Tonale Lino Laminate



Soga (Giro Collection)

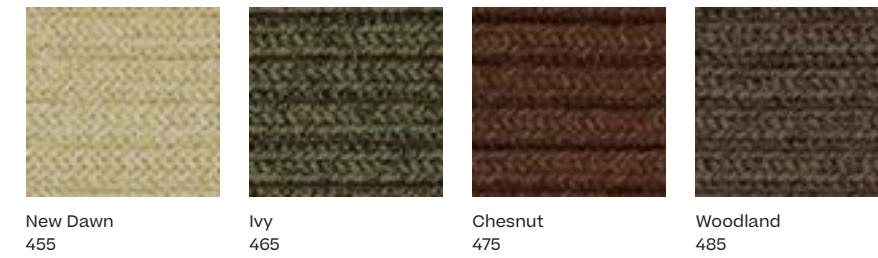

Maya curtains (outdoor)

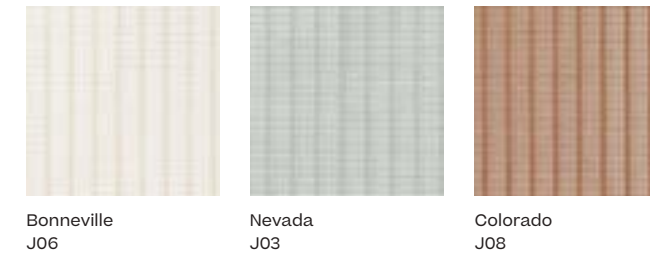

Plain Bela rope



Basalt Z01, Shore Line Z02, Nimbus Z03, Polar White Z04, Dry Vine Z05, Reed Z06, Dusk Z07, Riverbed Z08, Terra Firma Z09



Chestnut Z10, Black Cacao Z14, Gypsum Z11, Dragon Tree Z12, Sumac Z13, Mader Root Z15, Red Mud Z16, Tumeric Z19, Champa Z20

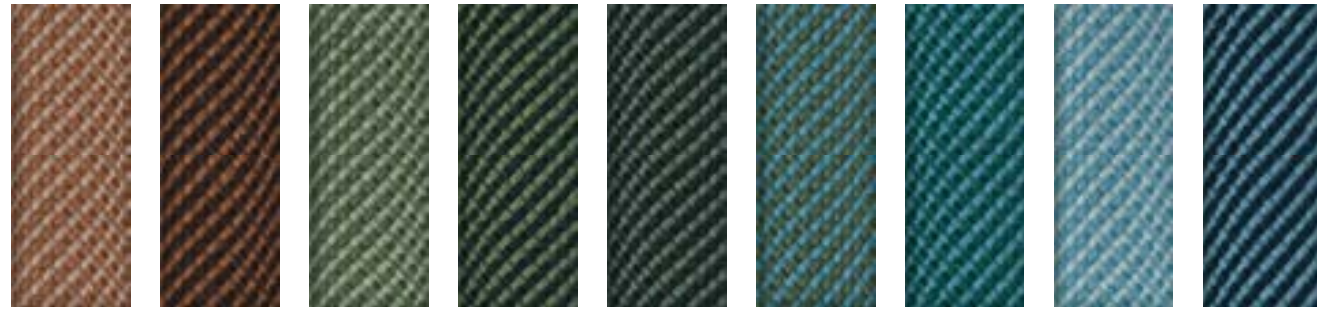

Charoli Z18, Tamarind Z17, Bitter Goud Z21, Foilar Z22, Evergreen Z23, Sea Grass Z25, Teal Z24, Azur Z28, Blue Slate Z29



Midnight Z30, Lavandin Z27, Treetop Z26

Round Bela rope

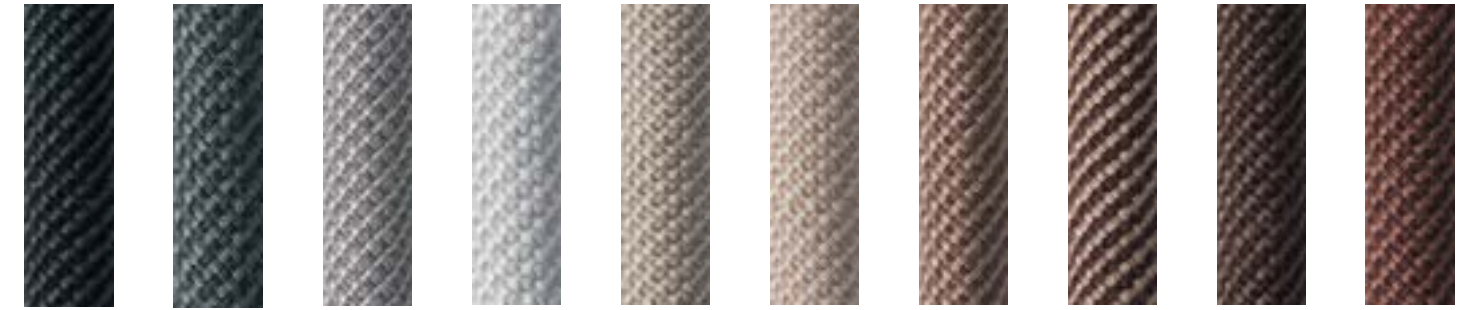

Basalt Z01, Shore Line Z02, Nimbus Z03, Polar White Z04, Dry Vine Z05, Reed Z06, Dusk Z07, Riverbed Z08, Terra Firma Z09, Chestnut Z10



Black Cacao Z14, Gypsum Z11, Dragon Tree Z12, Sumac Z13, Mader Root Z15, Red Mud Z16, Tumeric Z19, Champa Z20, Charoli Z18, Tamarind Z17

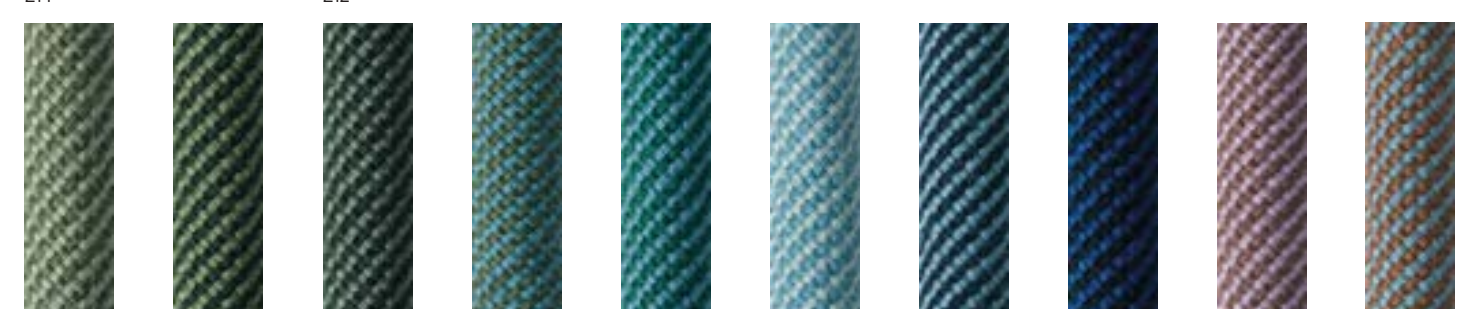

Bitter Goud Z21, Foilar Z22, Evergreen Z23, Sea Grass Z25, Teal Z24, Azur Z28, Blue Slate Z29, Midnight Z30, Lavandin Z27, Treetop Z26

Terrain Paint

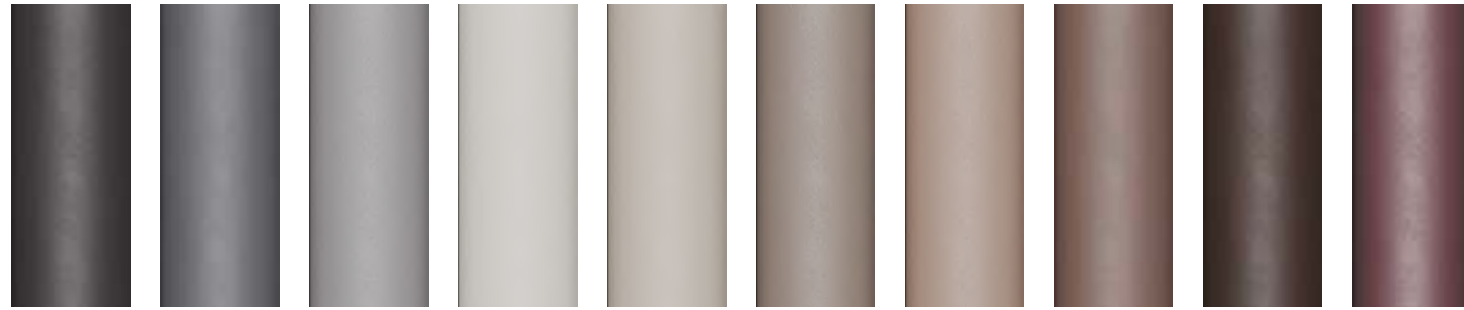

Slate Stone 01C, Misty Smoke 02C, Ash 03C, Bone 04C, Tuff 05C, Wet Stone 06C, Sand Dune 07C, Dry Clay 08C, Arabica 09C, Sepia 19C

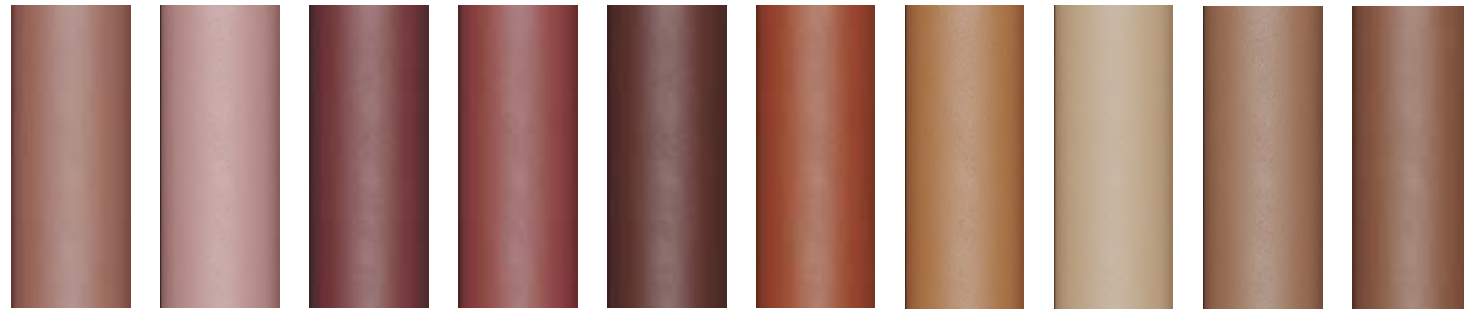

Rose Canyon 16C, Blossom 20C, Ruby Dust 18C, Sunset Glow 17C, Terrarosa 15C, Terracota 14C, Amber 13C, Ginger Root 12C, Desert Storm 11C, African Savannah 10C

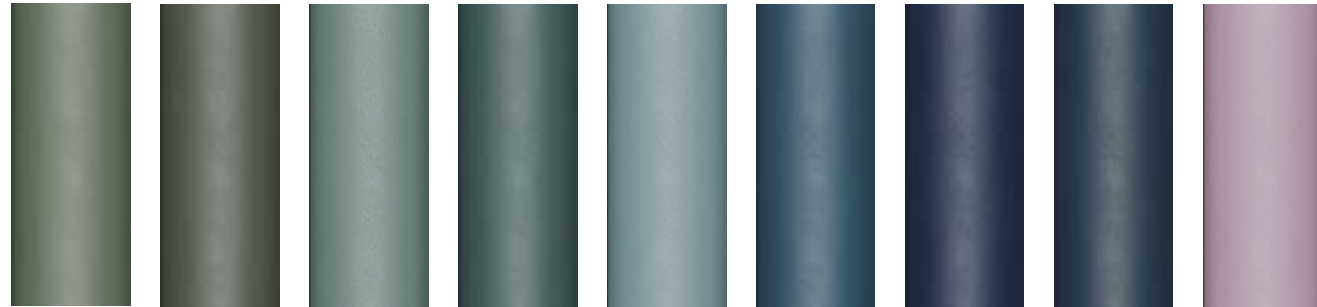

Spring Meadow 28C, Kombu 29C, Forest Stream 27C, Sea Moss 26C, Glacier Ice 25C, Polar Sky 24C, Nightfall 23C, Indigo 22C, Wild Lupin 21C



Galena 33C, Bronze 30C, Corten 31C, Manganese 32C

Materials

Ceramics



Ceppo di gre (Pavilions), Du Gent Grey (Giro/Base Kitchen), Neutral Caliza (Giro/Base Kitchen), Royal Black (Giro)

Glaze paints

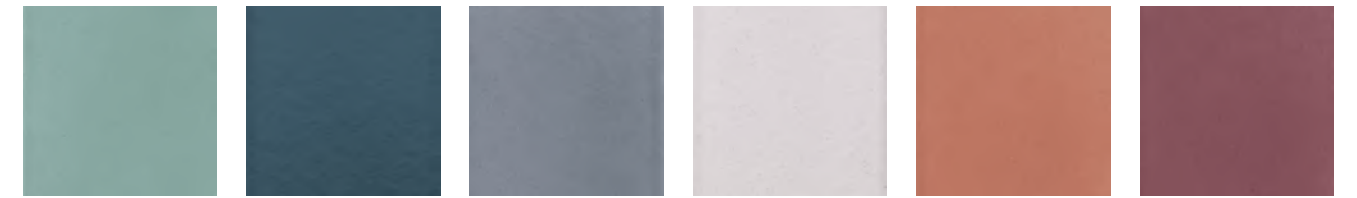

Erinite 376, Montana 377, Indian Sapphire 371, Dolomite 373, Obsidian 372, Jasper 375

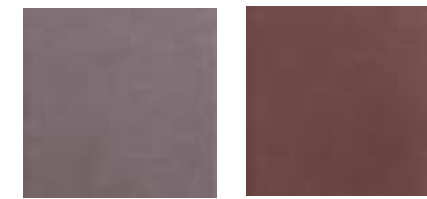

Black Diamond 374, Smoky Quartz 370

Minera

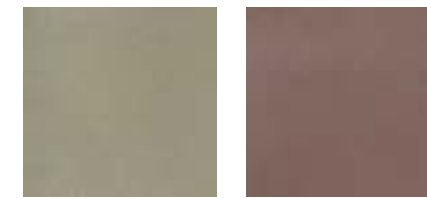

Antique Rose MI3, Atlas MI4

Wood



Teak, Cinnamon teak

Aluwood

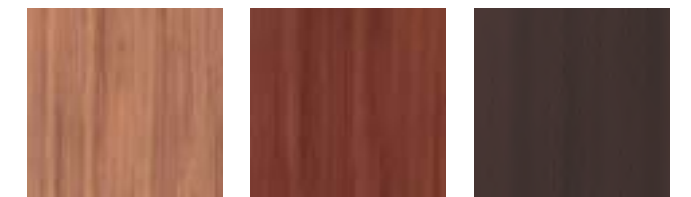

Atlantic White Cedar 930, Western Red Cedar 920, Smoked Wenge 910

Parallels

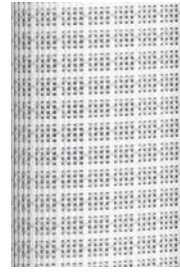

White Anemone
527



Lace Coral
528

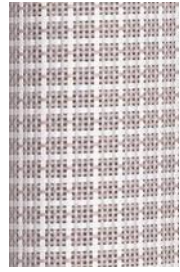

Padina
564



Saline
571



Alaria
572



Sponge
536



Fucus
537



Urchin
547



Kelp
556



Turtle Grass
553



Deep Ocean
570



Winter Sea
569



Xenia
568



Plumaria
567



Irish Moss
559



Coral
562



Dulse
565

Parallels (Porotex)

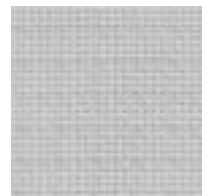

White Salt
989



Silver Moon
990



Sea Shell
991



Beach Sand
992



River Sand
988

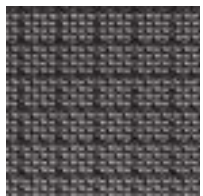

Black Urchin
993

Shelter fabrics

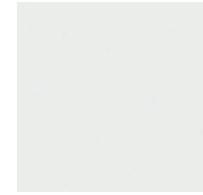

Cenit Sky
860



Cloudy
862



Sun Shine
865



Desert Storm
866



Stormy Sky
863



Mud Storm
867



Boreal
864



Sun shade
861

Roller blind fabric



Pearl Linen
795



Ebony Sand
793



Ebony Bronze
796

Leather



Light Brown
350



Dark Brown
352



Taupe
351

Roll Straps



Cotton
CR1

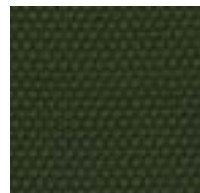

Calatea
CR2

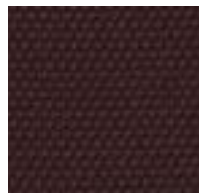

Plume Thistle
CR3

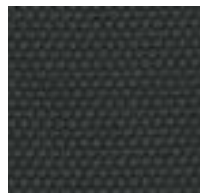

Burnt Wood
CR4

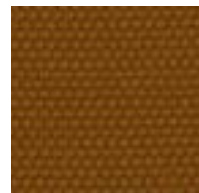

Sun Flower
CR5

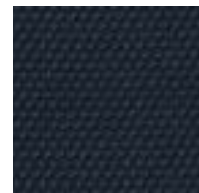

Sea Holy
CR6

Piping



Rosemary
MR1



Whole Clove
MR2



Mustard Grain
MR3



Sea Salt
MR4



Ground Pepper
MR5



Black Salt
MR6



Poppy Seed
MR7



Rose Harissa
MR8

Line Rugs

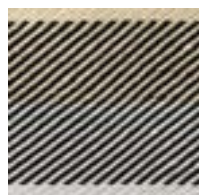

White Saltflats

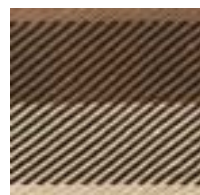

Volcanic Dust

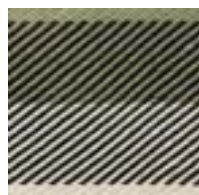

Highlands Valley

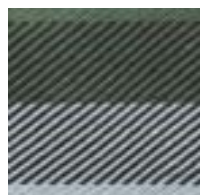

Northern Lights

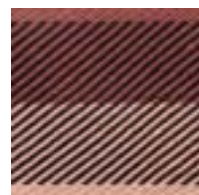

Slot Canyon



Atacama Desert

Block Rugs

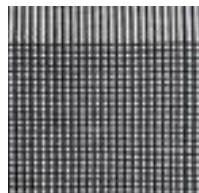

White Saltflats

Materials

Waranty terms

For domestic use, all products, except for cushions, covers and fabrics (including textillines), are guaranteed for a period of five years against any manufacturing defect that affects their suitability for use. This guarantee does not apply to normal conditions of use and maintenance. This guarantee does not apply to faults or imperfections resulting from the passage of time or normal wear and tear. Circumstances not covered by this guarantee include, but are not limited to, the fading or change in shade of colours, changes in wood texture, scratches resulting from use, etc. For non-domestic use, by the hotel and catering industry and collectives for example, all products, except cushions, covers and fabrics, are guaranteed for a period of two years. This guarantee is subject to the same conditions as outlined above.

Technical specifications

Committed to innovation and quality, Kettal's collections are manufactured to the strictest quality standards, from the selection of the materials, to the quality and safety testing of the furniture.

IMO Certification

Upon request, we can certify our products under the IMO standards.



See all the finishes colors of each image here

Cala Collection Images
page: 142-145

Proyecto: Casa TM
Arquitectura: Casas de México / @
cdmcasasdemexico
Fotografía: Rory Garidner / @
arorygardiner

Giro Collection Images
pages: 64-65, 70-73
copyright. Winery VV

Architect: Vincent Van Duysen

Giro Collection Images
pages: 68-69
copyright. Villa Mandra by K-Studio.
brechenmacher-baumann.com

Roll copyright images
page: 176-177
Project | Dalkeith, Perth, Australia

Architect: Brooking Design
Builder: Palazzo Homes
Photography: Gathering Light
Interior Design & Styling: Jill Owens
Interiors

We would love to hear from you.

Head office

Kettal Barcelona
Aragón, 316
08009 Barcelona, Spain
T. (34) 93 487 90 90
F. (34) 93 487 90 66



Download our
Workplace catalogue



Download our
Contract catalogue

Showrooms

Kettal Barcelona
Aragón, 316
08009 Barcelona, Spain
t. (34) 93 488 10 80
tienda.bcn@kettal.es

Paris Showroom
80, Blvd Malesherbes
75008 Paris, France
t. (33) 1 43 59 51 40
boutique.paris@kettal.es

Miami Showroom
147 Miracle Mile
Coral Gables,
Florida 33134, USA
t. (1) 786 552 90 22
miami.store@kettal.es

Marbella Showroom
Crtra. de Cádiz, Km.179
(entre el Marbella Club
y el Guadalpin)
29600 Marbella, Spain
t. (34) 95 277 89 89
tienda.marbella@kettal.es

London Showroom
Residential
567 Kings Road,
London SW6 2 EB
t. (44) 20 7371 5170

New York
The D&D Annex:
222 East 59th Street
Suite 222-333
New York, NY 10022, USA
t. (1) 917-992-9419
newyork.showroom@kettal.com

Chicago
The Mart.
222 Merchandise Mart Plaza,
Suite 10-155
Chicago, IL 60654 USA.
T. 312.244.0527
chicago.showroom@kettal.es

London Showroom
Contract & Workplace
15-16 Dufferin St,
London EC1Y 8UR, Reino Unido
t. +44 7507 717891

Melbourne Showroom
510 Church Street Melbourne
Richmond VIC 3121, Australia
t. (03) 9957 8799