

# VIS À VIS

PIERGIORGIO CAZZANIGA



## DESCRIPTION

The chairs of the Vis à vis collection all combine ergonomic seating comfort with a natural look. Check out the rounded corners of the teak frame and the airy Canax® weave in one continuing flowing line from the seat to the back. The weather-proof Canax® straps are made with natural hemp and give these chairs a very natural, harmonious look. The lounge on the other hand, has an integrated tabletop, made of square slats and is designed in a way that two sunbeds fit into each other. These square slats are continued in the design of the dining tables. By repeating its one modular element, you can make a table as long as you want.

## MATERIALS

- Frame: plantation teak from East-Java, every part is handpicked during the cutting process of the tree
- Seat & back: plaited Canax® straps (polyester coated with a mix of solution dyed PVC and natural hemp). UV-, rot and mildew resistant
- Hardware: 316L electropolished stainless steel
- Table: tabletops of 99 x 99 cm can be attached to each other with 304L powdercoated stainless steel support bars to create the table length of your liking

## CUSHIONS

Filling in dryfoam which has an open cell structure, so air can circulate freely. Water passes through the filling, but dries quickly thanks to the large open pores, substantially inhibiting fungal growth. Fabrics available in category D, E & F.

## COLOURS STRAPS

85-Earthbrown



# VIS À VIS

## TECHNICAL DRAWINGS

01718 - Armchair

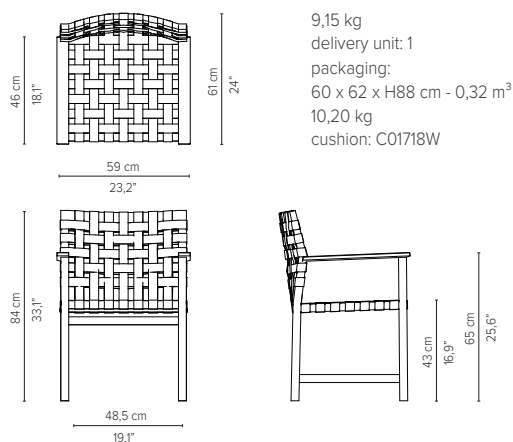

01740 - Adjustable lounger

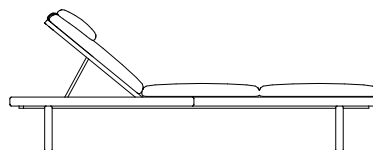

01741 - Adjustable lounger with 2 wheels

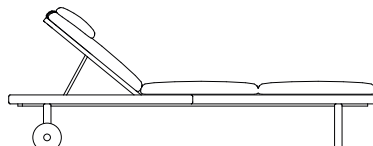

Option:  
 01740 W - set of 2 wheels

delivery unit: 1  
 packaging:  
 28 x 27 x H15,5 cm - 0,01 m<sup>3</sup>  
 3,20 kg

01712 - Lounge chair

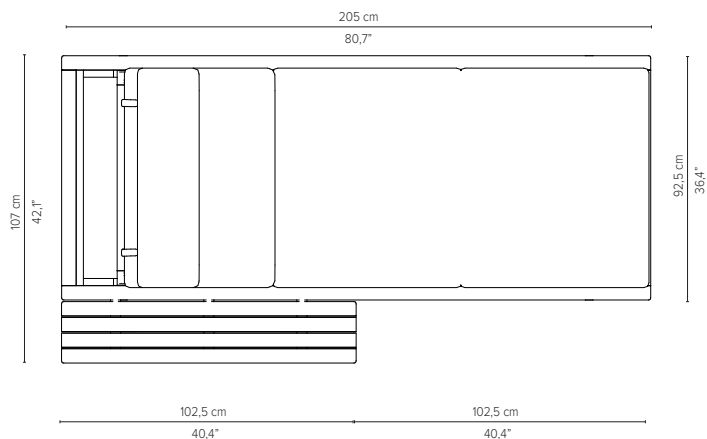
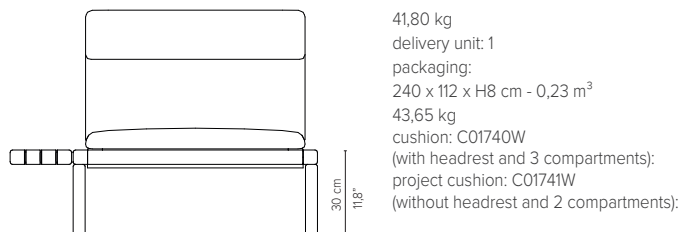
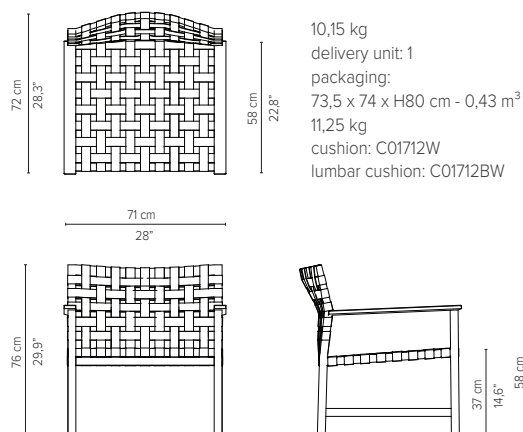

01713 - Rocking chair

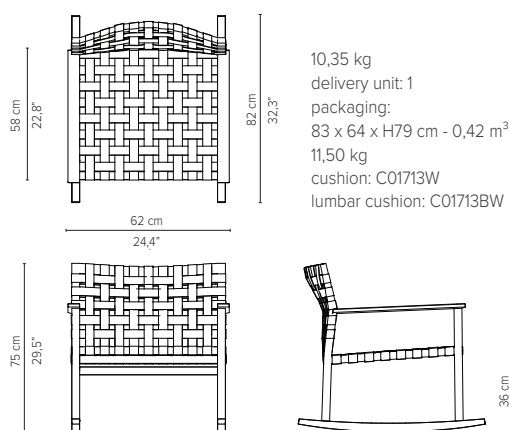

The bed base can be taken out so you can lie next to each other or towards each other

\* Appearances, measurements and weights may slightly differ from reality.  
 The cushions on the drawings are not included in the article.

# VIS À VIS

## TECHNICAL DRAWINGS

### Legend

packaging A:  
table top  
33,05 kg  
103 x 102 x H7 cm - 0,07 m<sup>3</sup>

packaging B:  
set of legs  
8,70 kg  
77 x 59 x H13 cm - 0,06 m<sup>3</sup>

packaging C:  
set of support profiles  
21,70 kg  
166 x 15 x 10 cm - 0,03 m<sup>3</sup>

packaging D:  
set of extension profiles  
9,80 kg  
122 x 15 x 6,5 cm - 0,01 m<sup>3</sup>

01773 - Table 99 cm

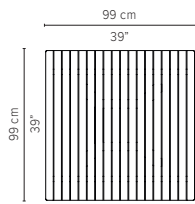

40,20 kg  
1 x packaging A  
1 x packaging B  
0,14 m<sup>3</sup>

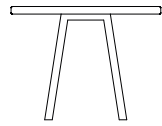
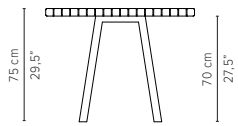

01753 - Table 300 cm

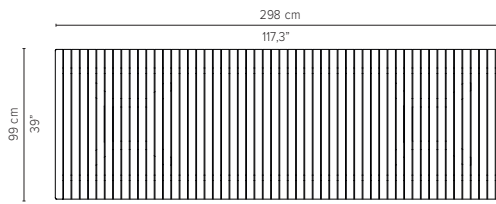

134 kg  
3 x packaging A  
2 x packaging B  
1 x packaging C  
0,38 m<sup>3</sup>

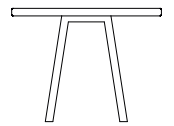
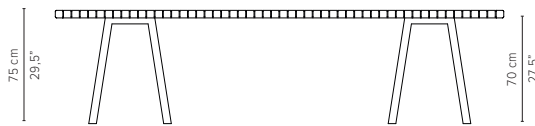

01754 - Table 400 cm

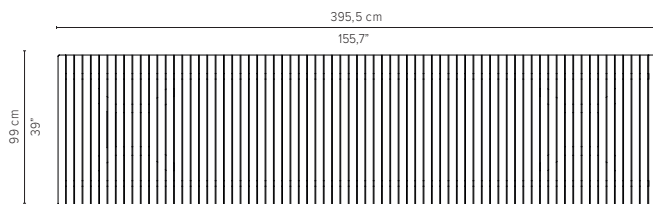

175 kg  
4 x packaging A  
2 x packaging B  
1 x packaging C  
1 x packaging D  
0,47 m<sup>3</sup>

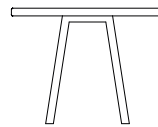
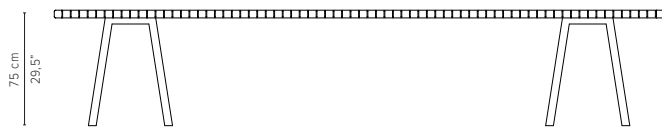

From a length of 5 m or more, a third set of legs will be added

01755 - Table 500 cm/197"

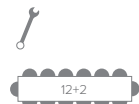

225 kg  
5 x packaging A  
3 x packaging B  
1 x packaging C  
2 x packaging D  
0,62 m<sup>3</sup>

01756 - Table 600 cm/236"



267 kg  
6 x packaging A  
3 x packaging B  
1 x packaging C  
3 x packaging D  
0,67 m<sup>3</sup>

01757 - Table 700 cm/275"

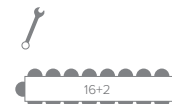

308 kg  
7 x packaging A  
3 x packaging B  
1 x packaging C  
4 x packaging D  
0,80 m<sup>3</sup>

# VIS À VIS

---

## PROTECTION COVERS

For each item a cover is available that protects the furniture against dirt. These covers in grey colour are made of PU coated polyester which is water-repellent and UV-resistant. Thanks to their excellent breathable qualities the covers reduce condensation and heat build-up, helping to prevent the formation of mold and mildew. Nevertheless, they are not 100% waterproof. Always make sure that furniture, cushions and covers are completely dry before covering furniture.

## MAINTENANCE

### Teak

Treat new teak with Teak Protector 4 à 6 weeks after installation. Teak Protector applies an invisible film that prevents stains and green deposit. Soiled teak can be cleaned with Teak Super Cleaner. Leave the furniture to dry completely and then apply Teak Protector. To avoid labour-intensive cleaning, you can treat the wood with Teak Sealer. A simple cleaning with water and a ph-neutral soap will do for many years. Teak Sealer contains UV protection to slow down the graying from the sun as well as a fungicide to prevent the growth of mold and mildew.



D9914  
Teak Super  
Cleaner



D9912  
Teak Protector



D9959  
Teak Sealer

### Canax® straps

Clean with clear water and a pH neutral soap. Stubborn stains and persistent green deposit can be removed with Synthetics Super Cleaner. Use a soft brush to clean between the weave.



D9922  
Synthetics  
Super Cleaner

# VIS À VIS

---

## TECHNICAL STANDARDS

### 01718 Armchair

ANSI/BIFMA X5.1-2011

EN1022:2005 6  
EN581-1:2006 5  
EN 1728:2012

ASTM B117-11 (MOD.)

CPSD-HL-01010-MTHD  
CPSD-HL-01012-MTHD  
CPSD-HL-01063-MTHD

AATCC 16  
AATCC 106  
AATCC 162



### 01712 Lounge chair

ANSI/BIFMA X5.1-2011

EN1022:2005 6  
EN581-1:2006 5  
EN 1728:2012

ASTM B117-11 (MOD.)

CPSD-HL-01010-MTHD  
CPSD-HL-01012-MTHD  
CPSD-HL-01063-MTHD

AATCC 16  
AATCC 106  
AATCC 162



# VIS À VIS

PROJECT REFERENCES



Gran Hotel, Ibiza – Vis à Vis loungers



Shloss Elmau, Krün, Germany – Vis à Vis armchair and table 99 x 99 cm



Les Cures Marines, Trouville, France – Vis à Vis loungers